

EarthLogger User Manual

Model: EL4+



EarthLogger™ User Manual

The software described in this manual is supplied under a license agreement and may be used only in accordance with the terms of that agreement.

Publication History

Version	Date	Status	Comment	Author	App'd
0.1	08Jan2014	Withdrawn		CG	RG
0.2	22Apr2014	Withdrawn		CG	RG
0.3	25Sep2014	Withdrawn		CG	RG
0.5	14Oct2016	Withdrawn	Reformatted.	AS	RG
1.04	25Nov2016	Withdrawn	Major re-write. Cloud Server section removed.	AS	RG
1.05	05Sep2018	Withdrawn	Minor changes.	CG	RG
1.06	19Mar2019	Withdrawn	Added default user login details	LH	CG
1.07	20April2020	Withdrawn	Clarified items	LH	CG
1.08	22Sep2021	Current	Changed to EL4+	LH	CG

Copyright Notice

©2016 MRD Rail Technologies Pty Ltd. All rights reserved.

Trademarks

The MRD logo is registered trademark of MRD Rail Technologies Pty Ltd.

All other trademarks or registered marks in this manual belong to their respective holders.

Disclaimer

Information in this document is subject to change without notice and does not represent a commitment on the part of MRD Rail Technologies Pty Ltd.

MRD provides this document as is, without warranty of any kind, expressed or implied, including, but not limited to, its particular purpose. MRD reserves the right to make improvements and/or changes to this manual, or to the products and/or the programs described in this manual, at any time.

Information provided in this manual is intended to be accurate and reliable. However, MRD assumes no responsibility for its use, or for any infringements on the rights of third parties that may result from its use.

This manual, and the product it relates to, might include unintentional technical or typographical errors. Changes are periodically made to the information herein to correct such errors, and these changes are incorporated into new edition of the publication.

Technical Support Contact Information

Tel: +61 7 3821 5151

Fax: +61 7 3821 5152

Email: support@mrd.com.au

Table of Contents

1. INTRODUCTION	5
2. PRODUCT DESCRIPTION	6
2.1 Insulation Monitoring	6
2.2 Voltage Monitoring	7
2.3 ELDs	7
2.4 Insulation Resistance- Principle of Measurement	7
2.5 User Authentication	7
2.6 External Communications/Activations	7
2.7 Logging & Uploading	8
2.8 Connectors.....	9
2.9 Package contents	10
3. INSTALLATION	11
3.1 Hardware	11
3.1.1 Hardware installation	11
3.1.2 Product Dimensions	11
3.1.3 Panel Mount Hole Spacing	11
3.2 Electrical Installation.....	12
3.2.1 Basic Electrical Connections	12
3.2.2 Wiring Diagrams	13
3.2.3 Connect Power Supply	16
3.2.4 Initialisation	16
3.3 Basic Configuration	16
3.3.1 Access the Web Server	16
4. OPERATION	17
4.1 General notes	17
4.2 Entering Numeric Values.....	18
4.2.1 Typical numeric entry process (Input Password shown).....	18
4.3 On-Device Configuration	19
4.3.1 Menu Structures.....	19
4.3.2 Channel Setting Menu.....	19
4.3.3 Unit Setting Menu	20
4.3.4 Relay Setting Menu	20
4.3.5 Password Setting	20
4.4 Test & Reset.....	20
4.5 RS485 Connection	21
5. EMBEDDED WEB SERVER	22
5.1 Connect to the Web Server	22
5.2 Login	22
5.3 View Data	23
5.3.1 Graph.....	23
5.3.2 Data	25
5.3.3 Test.....	25
5.4 Download Data	26
5.5 Debug Info	26
5.6 Config Menu	27
5.6.1 EarthLogger Config.....	27
5.6.2 Relay Config.....	28
5.6.3 Misc Config.....	28
5.6.4 ELD Config	29
5.6.5 3G Config.....	29
5.6.6 VPN Config.....	29

5.6.7	SMTP Config	29
5.6.8	SNMP Config.....	30
5.6.9	Login Config.....	30
5.7	System upgrade	30
5.7.1	Firmware Management.....	30
5.7.2	Application Management.....	31
5.7.3	Web Management	31
5.7.4	System Upgrade	31
6.	WARRANTY	32

1. INTRODUCTION

EarthLogger is a Condition Monitoring and Logging device. Condition Monitoring reduces equipment failures and accidents due to current leakage faults. Two common faults locations are Batteries and Circuits.

Leakage from battery

The interlocking circuits in railway signalling may be supplied from a battery having no earth connections. A single fault presents no danger, however simultaneous faults may create a hazard. Continuous monitoring will alert operators when one or more Earth Leakage events occurs.

Leakage from cables, lamp circuits etc.

Cables that run parallel with AC electrified railways are subject to induced voltages. When earth leakage occurs in these cables, the induced voltages may disturb connected devices. A hazard may be created if Earth Leakage occurs in Supply and Return cables.

EarthLogger remotely monitors, logs and responds to the Insulation Resistance and Voltage of up to four attached busbars. EarthLogger can also log and respond to the outputs from up to four MRD ELD devices. EarthLogger enables fault notifications by email, activation of local or remote alarms, and the forensic examination of leakage or voltage fluctuation trends and events.

2. PRODUCT DESCRIPTION

EarthLogger monitors and records the Insulation Resistance (IR) and or Voltage of up to four attached circuits (Channels), and four MRD ELD devices. The device can be setup to recognise when IR or Voltage drifts out of the acceptable range, and to generate alerts when such conditions occur.

EarthLogger includes an embedded Web Server able to control the device, change configurations, and view logged data.

2.1 INSULATION MONITORING

EarthLogger alerts system operators if Insulation Resistance falls below a user-selected trip value for longer than a pre-set period. Alert devices are:

- On-screen display
- Illuminated LED
- Relay operation to activate external equipment
- Communications using Ethernet or 3G/4G
- SNMP trap notification

For each Channel, there are two User selectable Insulation Resistance trip values, R_{AN1} and R_{AN2} , referred to as Pre-Warning and Warning. The Pre-Warning value must always be greater than the Warning.

In the event of an alert, until Reset, the device will (for the selected channel):

- Continue to monitor and display the current IR value
- Display the highest recorded alert State (Pre-Warning or Warning)
- If the IR or Voltage falls below the Warning level and continues beyond the Trip Delay period
 - Illuminate the corresponding LED
 - Activate Relay(s)

PreWarning and Warning have the following settable parameters:

- Trip (Response) Value ($k\Omega$)
- Trip Delay (seconds)
- Relay Activated (1 or 2)
- Activated Relay State (Safe or Non-Safe)

Reset are done manually (on the device) or remotely, using the Web Server or a connected Reset switch.

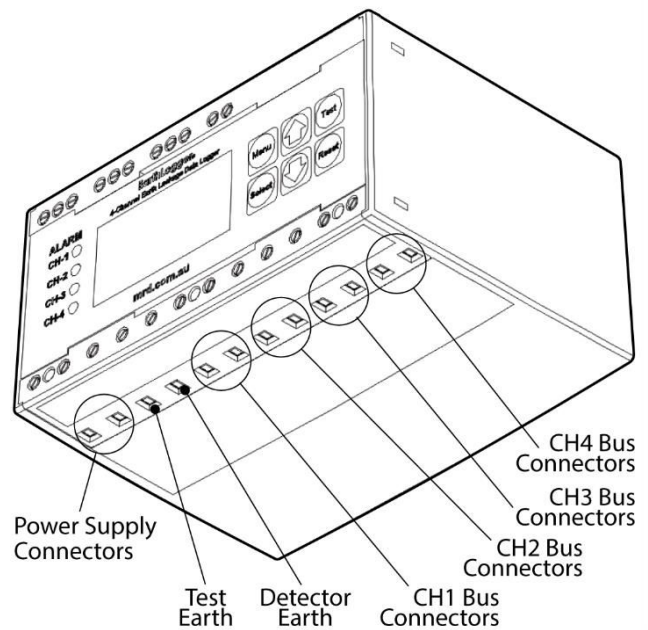
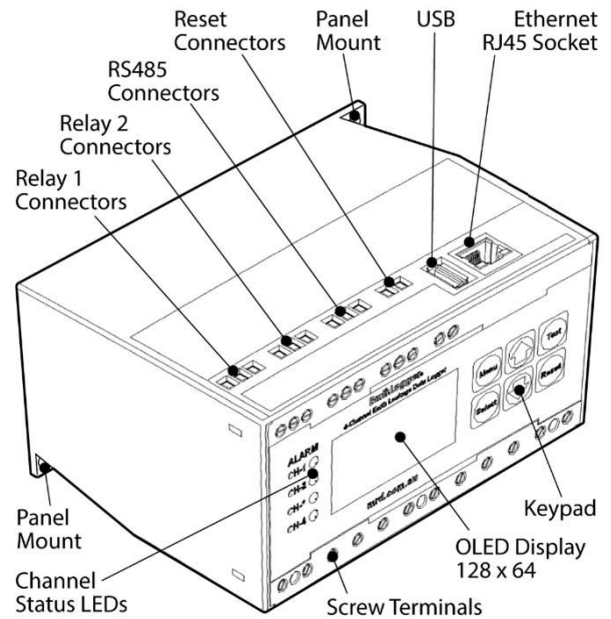

2.2 VOLTAGE MONITORING

Voltage monitoring detects over-voltage situations in connected equipment. For each Channel, there are two user selectable Voltage Trip values, referred to as V-PreWarning and V-Warning. The general scheme of operation and device responses is similar to Insulation Monitoring, except that the trip values are set to detect a rising voltage i.e. V-PreWarning is always less than V-Warning.

2.3 ELDs

Up to four MRD brand ELD devices may be connected using RS-485 Modbus.

The EarthLogger logs the incoming data and events. EarthLogger can be configured to respond to ELD generated alerts: on-screen display, activate Relays and send email notifications.

Connected ELDs are configured on the ELD itself. On the EarthLogger and Embedded Web Server, the settings are Read Only.

2.4 INSULATION RESISTANCE- PRINCIPLE OF MEASUREMENT

The Earthlogger measures Insulation Resistance using the current measuring principle. The Equivalent Circuit is shown at right, where R_F = Insulation Resistance and R_i = Internal Impedance.

The EarthLogger injects a polarity switching DC current into the attached Bus. Fault current is measured and used to calculate the Insulation Resistance (R_F), as shown below. The Equivalent Circuit is shown at right.

$$R_F = \left(\frac{V_m}{I_m} \right) - R_i$$

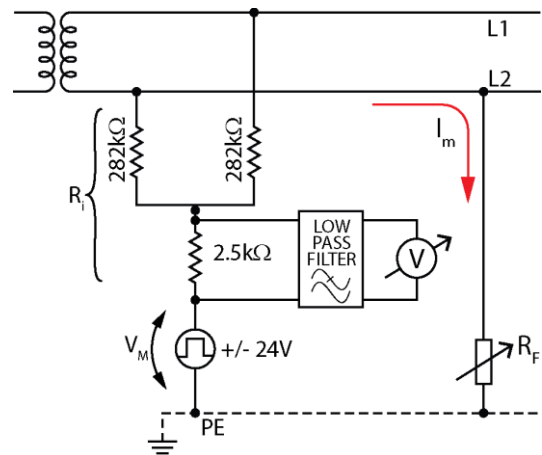

2.5 USER AUTHENTICATION

The device uses a Password to authenticate users and control ability to change device Settings. A Password is not required to view device status or current Settings. An authorised user is able to change the default password.

In the event of a lost password, the device can be unlocked using a Factory Password. Contact MRD to obtain the Factory Username/Password combination.

2.6 EXTERNAL COMMUNICATIONS/ACTIVATIONS

Network connections are established using Ethernet or a 3G/4G modem. The SIM card is fitted internally: the device must be opened to change or add a SIM card.

Two relays can activate external devices such as buzzers and lights, or connect to PLCs. Relays are set to be Safe or NonSafe.

2.7 LOGGING & UPLOADING

EarthLogger samples the Insulation Resistance and Voltage at 10Hz (10 samples per second).

To minimise the volume of data, logging occurs only if a change from the last recorded value is detected.

Sampling and Logging continues for all channels in the event of a PreWarning or Warning occurring.

If the network connection is lost, EarthLogger records up to 16Gb of data on internal memory (enough for several years). Logged data will be uploaded when the network is restored.

By default, EarthLogger uses Ethernet to connect to the Internet via a local network. If Ethernet is not available, EarthLogger attempts to connect using 3G/4G. It is possible to maintain simultaneous 3G/4G and Ethernet connections. The network architecture is shown below.

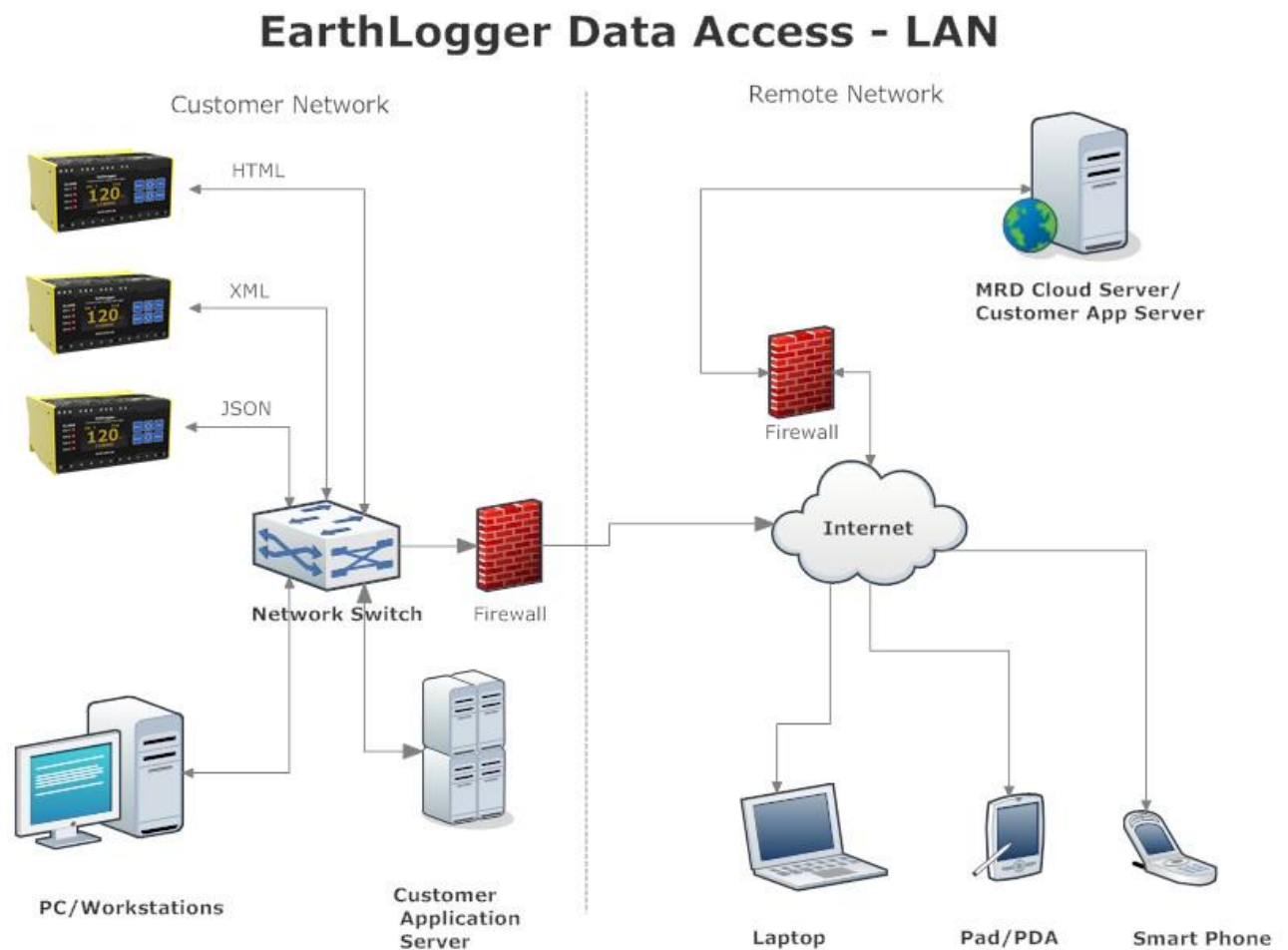

2.8 CONNECTORS

BOTTOM Connectors

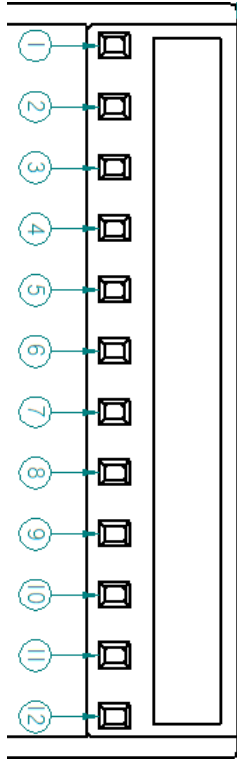
No.	Name	Description	Legend
#1	AC	AC Supply voltage input 85-264V AC, 50-60Hz	
	DC	DC Supply voltage input 120-370V DC	
#2	AC	AC Supply voltage input 85-264V AC, 50-60Hz	
	DC	DC Supply voltage input 120-370V DC	
#3	Det. Earth	Main earth	
#4	Test Earth	Use for testing earth integrity. Connect to #3 'Det.Earth' if not required	
#5	CH-1 AC/DC	Channel 1 AC/DC busbar	
#6	CH-1 AC/DC	Channel 1 AC/DC busbar	
#7	CH-2 AC/DC	Channel 2 AC/DC busbar	
#8	CH-2 AC/DC	Channel 2 AC/DC busbar	
#9	CH-3 AC/DC	Channel 3 AC/DC busbar	
#10	CH-3 AC/DC	Channel 3 AC/DC busbar	
#11	CH-4 AC/DC	Channel 4 AC/DC busbar	
#12	CH-4 AC/DC	Channel 4 AC/DC busbar	

TOP Connectors

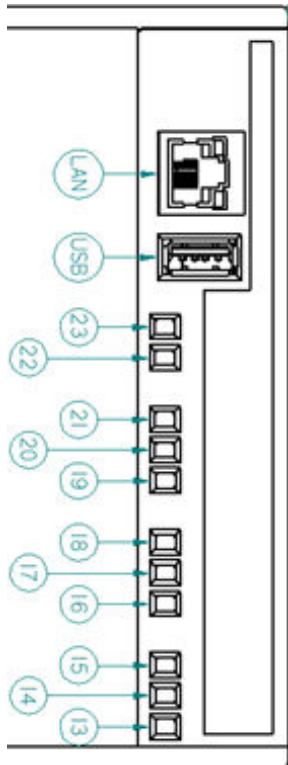
No	Name	Description	Legend
#13	RLY-1 – COM	Relay-1 Common Contact	
#14	RLY-1 – NO/Front	Relay-1 Normally Open/Front Contact	
#15	RLY-1- NC/Back	Relay-1 Normally Closed/Back Contact	
#16	RLY-2 – COM	Relay-2 Common Contact	
#17	RLY-2 – NO/Front	Relay-2 Normally Open/Front Contact	
#18	RLY-2 – NC/Back	Relay-2 Normally Closed/Back Contact	
#19	RS485-GND	RS-485 Ground. Internally connected digital signal ground	
#20	RS485-B	RS-485 comms.	
#21	RS485-A	RS-485 comms.	
#22	Reset	Remote Reset. Momentarily link terminal #22 & #23 to clear fault	
#23	Reset-GND	Remote Reset Ground. Internally connected digital signal ground	
ANT	ANT	Antenna of 3G modem	
LAN	LAN	Ethernet RJ45 connector	
USB	USB	USB host connector	

2.9 PACKAGE CONTENTS

Your EarthLogger package contains the following items:

- EarthLogger Unit
- 3G Antenna (36-120mm)
- Installation Guide
- Warranty Statement

If any of these items are missing or damaged, please contact our sales representative for assistance.

3. INSTALLATION

3.1 HARDWARE

3.1.1 Hardware installation

There are three recommended methods of mounting the EarthLogger

1. Mount EarthLogger on a 35mm DIN rail
 - a. The device snap fits to a standard 35mm DIN Rail
 - b. Use an insulated, flat-blade screwdriver to release the DIN Rail Clip
2. Mount using an optional Q-Style panel bracket
3. Panel mount using the flanges moulded into the case. Maximum fastener diameter: 3.5mm. A hole drilling guide is provided below

Note: Cable clearance is required above and below the EarthLogger. The clearances shown below will enable cables to be attached or removed with the device fixed in place. Inadequate clearance will result in difficult installations and excessively tight cable bends.

3.1.2 Product Dimensions

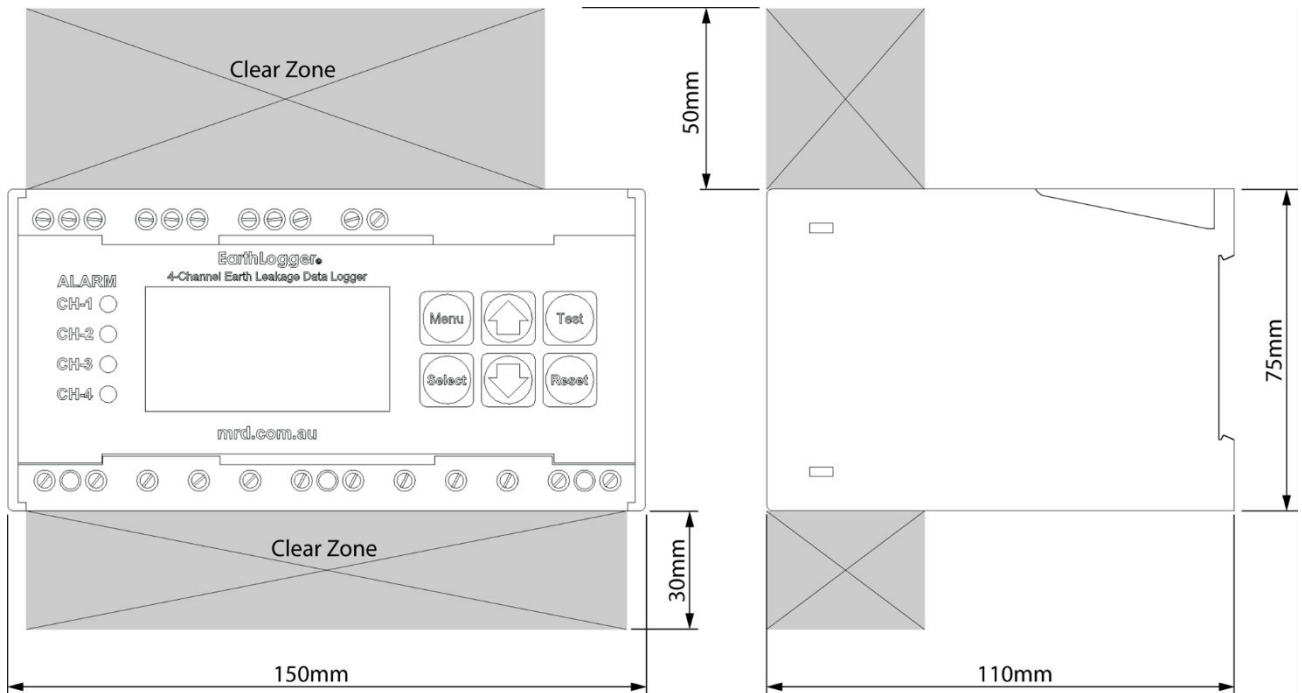

3.1.3 Panel Mount Hole Spacing

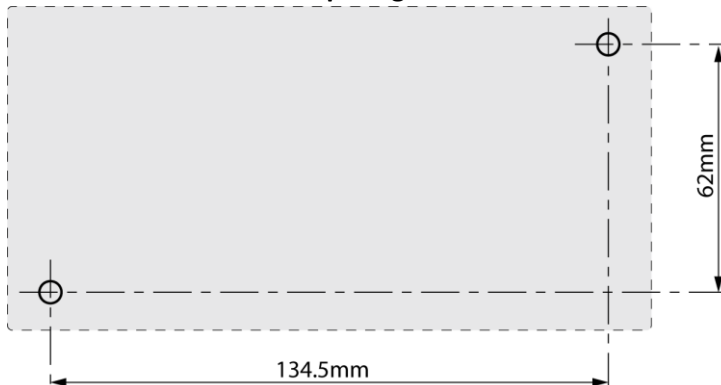

3.2 ELECTRICAL INSTALLATION

3.2.1 Basic Electrical Connections

3.2.1.1 Installation notes



- Dangerous voltages may be present. MRD recommends that buses are deactivated before connections are made
- Use appropriate Personal Protective Equipment when handling live connections
- Refer to Wiring Diagrams below
- Monitored Busbars can be AC or DC
- Connect only one busbar per channel
- DO NOT connect devices or Channels in parallel
- Bus connectors are in pairs: Connector 5 & 6; 7 & 8; 9 & 10; 11 & 12
- Extra care is required when connecting Bus cables to the device. DO NOT allow Bus Connections wires to touch any terminal other than the target connectors: the device will be damaged
- Tighten terminals to 0.5-0.6nm. Ensure all connections are tight before use

3.2.1.2 Test-Earth and Detector-Earth Connections

EarthLogger injects currents into attached circuits, and measures small differences in order to calculate the Insulation Resistance of the circuit. Self-Test places a 10KΩ resistor in circuit to validate the device. The injected current and responses may be very small compared to the attached circuit: The measuring circuit is sensitive to poor earth connections and excessive electrical noise.

There are two common methods of attaching EarthLogger Style devices, listed below. MRD recommends Method 2 as it has clear advantages over Method 1. The diagrams in section 3.2.3 are Method 1 style schemes.

The System Operator must develop a suitable Self-Test Schedule.

Method	Description	Comment
1	Test And Detector Earth are connected to Earth using separate cables and Earth Stakes to Ground	Possible issues: <ul style="list-style-type: none"> • Poor stake-to-stake Conductivity via earth • Broken wires will invalidate Self-Test result • Potential electrical noise introduced by external equipment or systems
2	Test and Detector Earth are connected to an Earth Bus, which is separately connected to Ground	Advantages: <ul style="list-style-type: none"> • Less opportunity for external noise to affect the Measuring Circuit • Broken Earth Bus to Ground cable will not affect Self-Test validity

3.2.2 Wiring Diagrams

Five common installation schema are:

- Three-Phase AC Bus
- Two-Wire DC Bus
- AC/DC Control Circuit
- Two-Phase AC Bus
- Dual-Pole DC Bus

3.2.2.1 Monitoring of Three Phase AC Bus

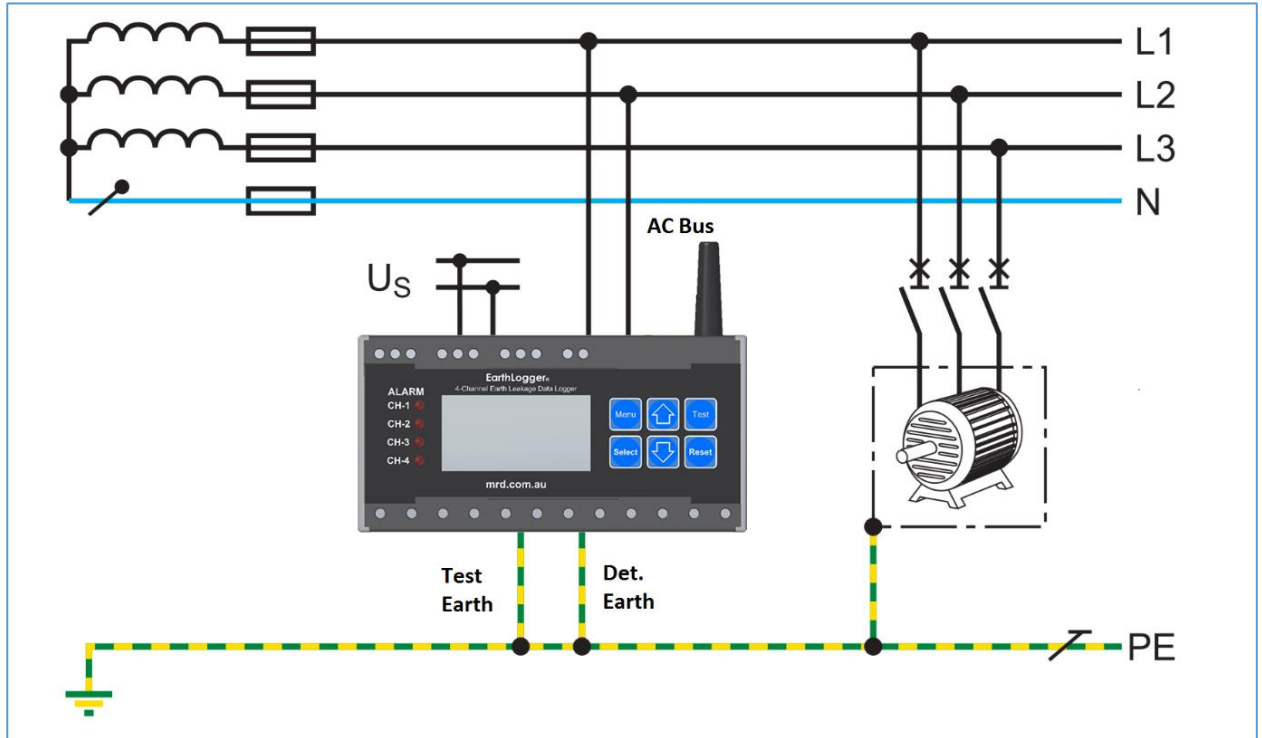

3.2.2.2 Monitoring of Two Wire DC Bus

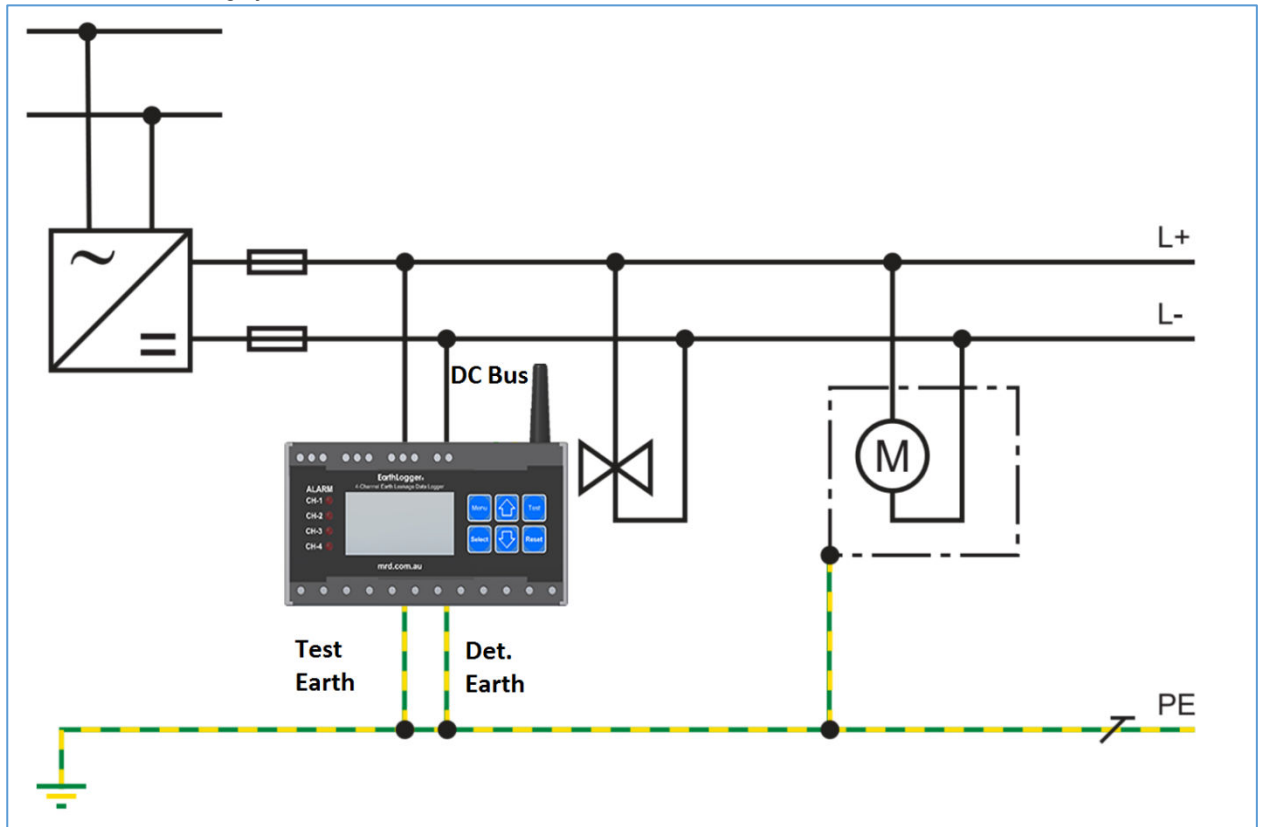

3.2.2.3 Monitoring of AC/DC Control Circuit

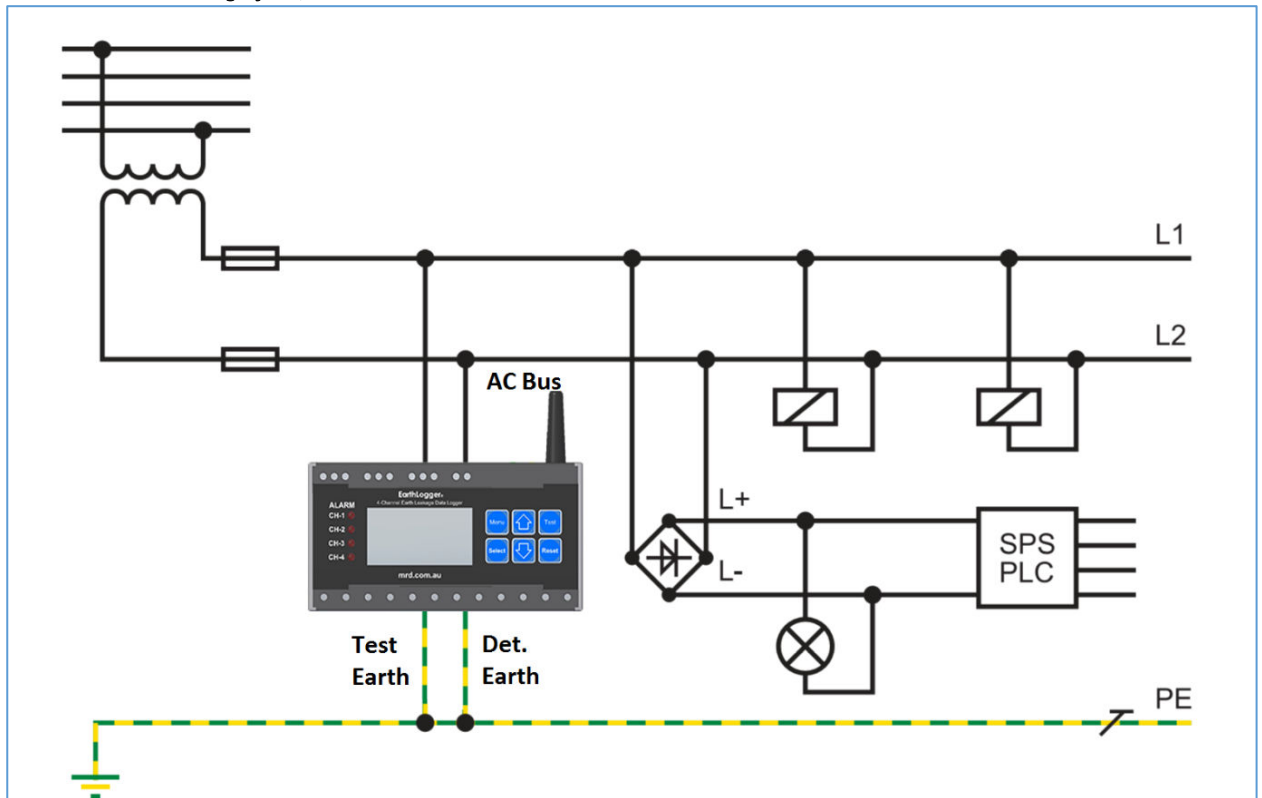

3.2.2.4 Monitoring of Two Phase AC Bus

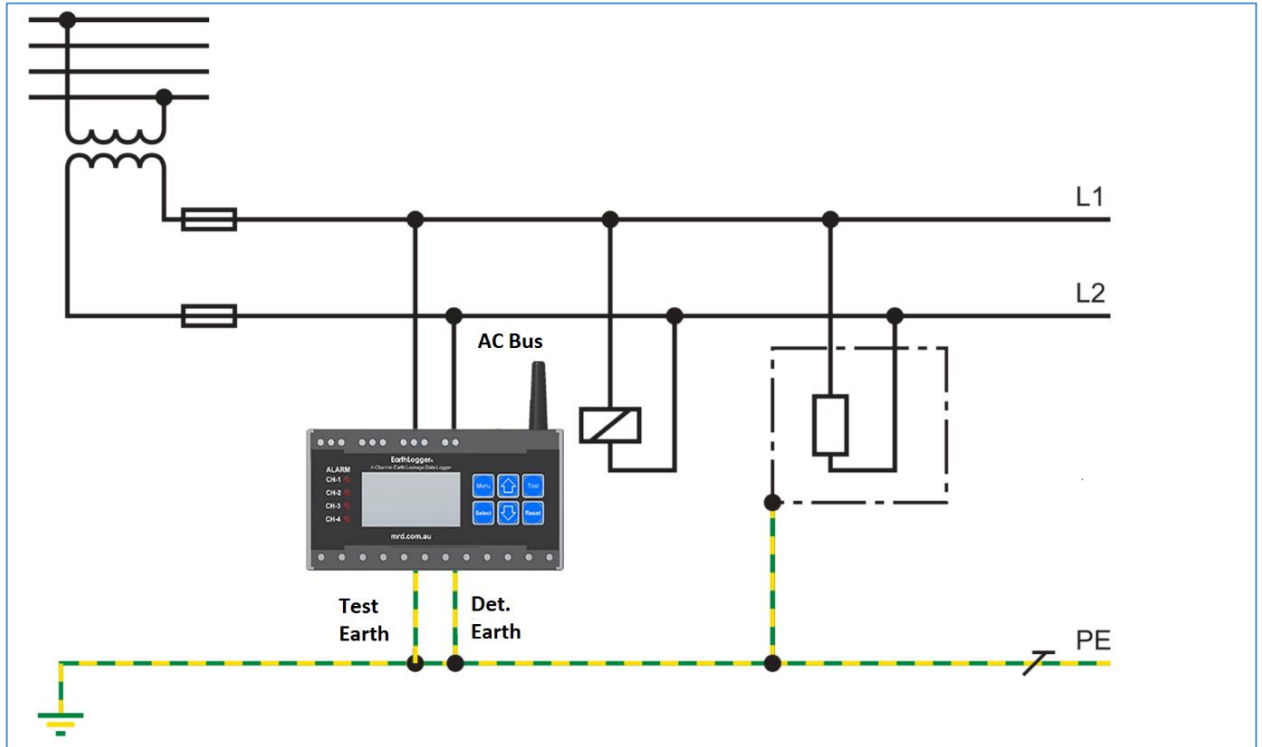

3.2.2.5 Monitoring of Dual Pole DC Bus

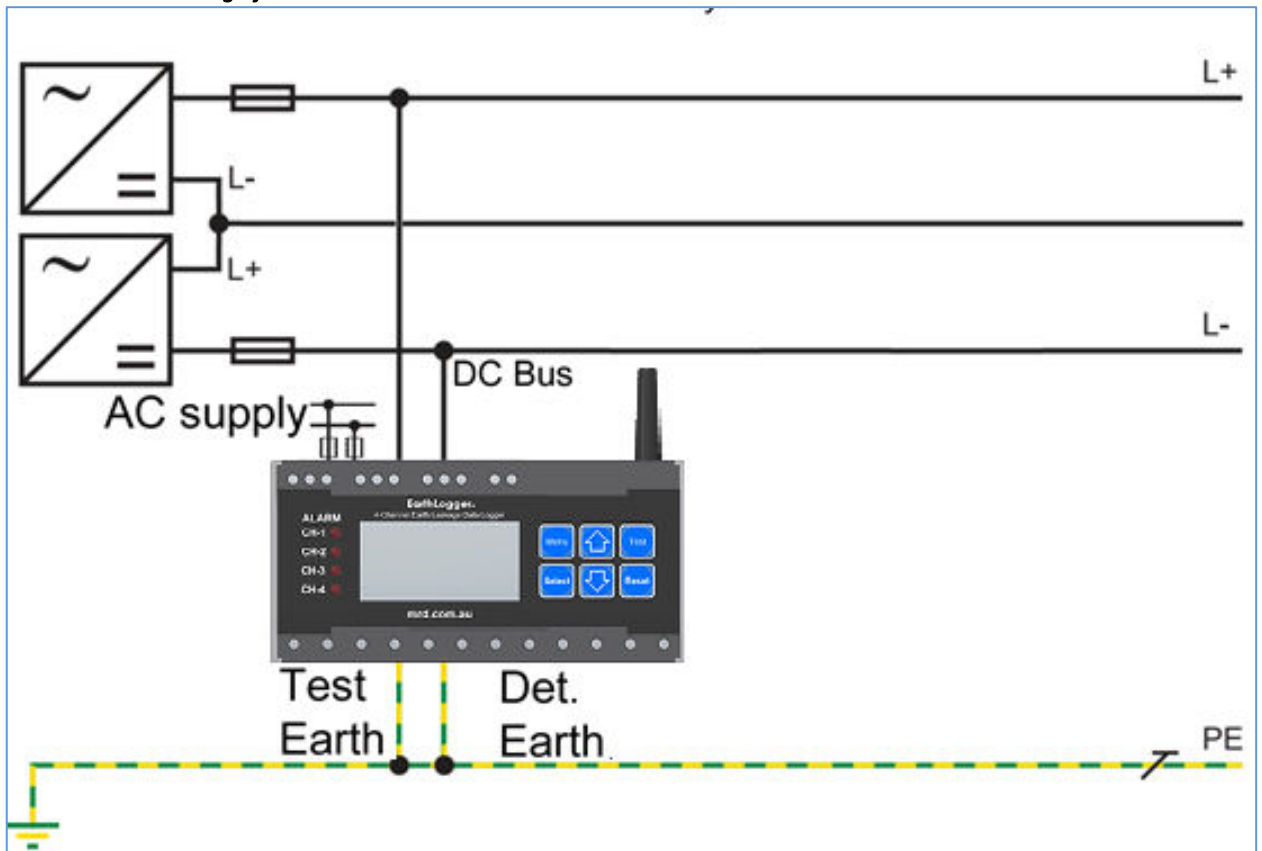

3.2.3 Connect Power Supply

At power ON, the EarthLogger will automatically detect the supply. Acceptable supply is 85 – 264V AC.

3.2.4 Initialisation

Following Power ON, the EarthLogger displays “Initialising...” for approximately 60 seconds. During this phase, the EarthLogger starts internal systems, attempts to find a DHCP server and obtain an IP address, unless Static IP is configured. If an IP address is not obtained or is not defined, the IP address will default to 10.0.0.251. The EarthLogger will attempt to obtain an IP address if a network is subsequently detected.

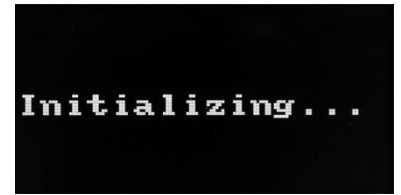

Following Initialisation, the EarthLogger will commence logging of all configured Channels, and display the status of Channel 1 (CH-1).

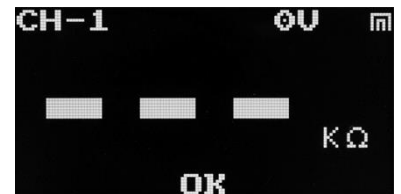

Note: Three LEDs may illuminate during initialisation: They are not significant.







3.3 BASIC CONFIGURATION

Device configuration can be completed using On-device menus or the Embedded Web Server.

MRD recommends configuring the EL4+ using the Embedded Web Server: It provides greater clarity, and is faster, easier and more efficient.

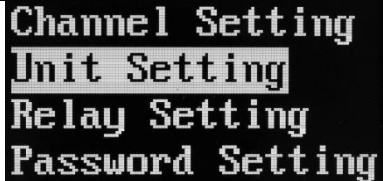
If no peer-to-peer or network connection can be established, the on-screen menu and keypad can be used to operate and configure many device parameters.

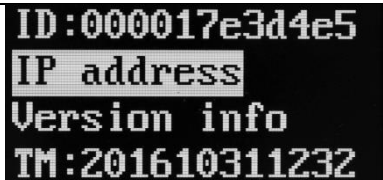
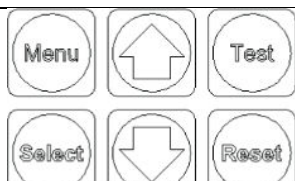
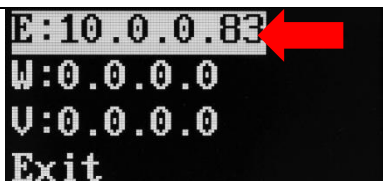

3.3.1 Access the Web Server

Task	Action	Display
<ul style="list-style-type: none"> At the EarthLogger device, press Menu 		
<ul style="list-style-type: none"> Use the Arrow keys to highlight Settings. Press Select 		
<ul style="list-style-type: none"> Use the Arrow keys to highlight IP Address. Press Select 		
<ul style="list-style-type: none"> Note the current IP address (E:) 		
<ul style="list-style-type: none"> Open a Web Browser and go to the IP address noted above. The embedded Web Server will appear 		

4. OPERATION

4.1 GENERAL NOTES



Feature	Sub-Feature	Function	Comment
OLED display	Auto Off	After 10 minutes of inactivity the current function will be cancelled and the display will turn OFF	Improves device security; Conserves energy and extends the display life
	Channel	The current Channel, from 1 to 4	
	Voltage	The voltage of the current Channel	0-650V AC, 0-650V DC
		Indicates Ethernet found	
	Leakage	Insulation Resistance of the current Channel. Displays up to 500kΩ	Values over 500kΩ are indicated by “- - -”
	Status Line	Indicates the status of the current Channel	Displays OK, PREWARNING, WARNING or TESTING
LEDs	Flashing RED	Current Channel is under TEST	
	Constant RED	Warning on the indicated Channel	
Buttons*	MENU	Call the Main Menu; Return to the previous menu	Disabled during a “Change Value” process
	SELECT	Selects highlighted item; Confirms or Saves current value and returns to the previous item or menu	
		Change current Channel; Navigate menu; Increase selected value	In rare instances, options may be displayed side-by-side. Use the arrow keys to alternate highlighting, and press Select to select the highlighted value
		Change current Channel; Navigate menu; Decrease selected value	
	TEST	Conduct Self-Test on current Channel. The TEST routine includes inserting a 10kΩ resistor into the measuring circuit.	If the PreWarning or Warning trip point is set less than 10kΩ, the device will enter and remain in the tripped state until RESET is Pressed.
	RESET	Clears a PreWarning or Warning on the current Channel	





*The Keypad functionality is context sensitive: the key actions may vary slightly between screens.

4.2 ENTERING NUMERIC VALUES

Numeric values are required for trip values, delay times, and passwords. The input method is similar in all situations:

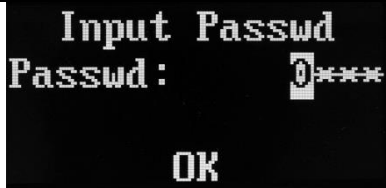
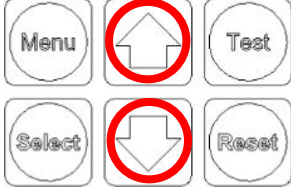
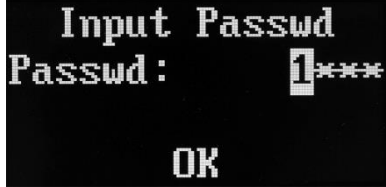
- Settable fields are presented for change as individual digits. Passwords are concealed
- If a low value is required, leading zeros must be used e.g.0050 = 50, 0005 = 5, etc
- Working from left to right, digits are set from 0-9 scrollable list. A final confirmation is required.

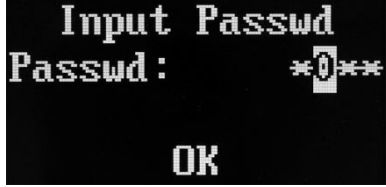
4.2.1 Typical numeric entry process (Input Password shown)

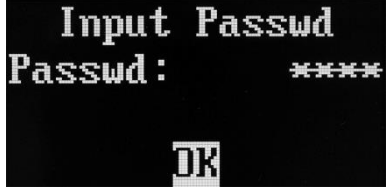
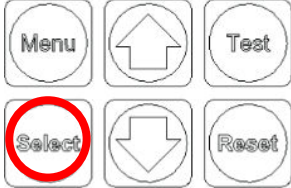
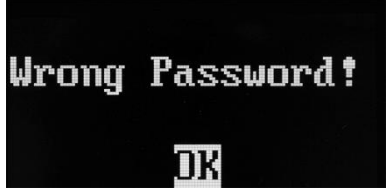
Task	Action	Display
<ul style="list-style-type: none"> • Input password 		
<ul style="list-style-type: none"> • Press UP or DOWN Arrows to change digit value 		
<ul style="list-style-type: none"> • Press SELECT to move cursor right • Repeat until Highlight moves to OK 		
<ul style="list-style-type: none"> • Press SELECT to Continue 		
<ul style="list-style-type: none"> • Incorrect Password • Message will be displayed • Press SELECT to continue 		

4.3 ON-DEVICE CONFIGURATION

4.3.1 Menu Structures

MRD recommends that on-device configuration be limited to setting a Static IP, if required. Complete all other configuration using the Embedded Web Server: there is greater clarity; easier; and more efficient.

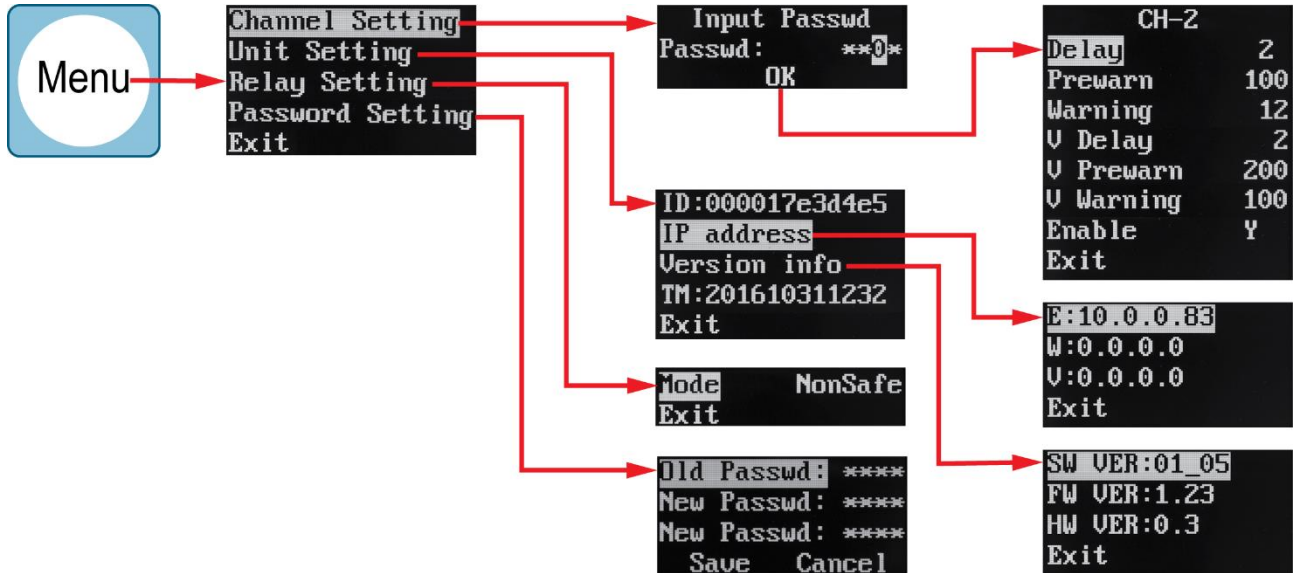

4.3.2 Channel Setting Menu

Setting	Description	Allowable Values
Delay	The Delay is the time that the insulation resistance must remain below the set value, prior to activation of the Pre-Warning or Warning alarms	2-10s
PreWarning	Non-Critical Fault insulation value - requires attention. For safety, the pre-warning value must be above 50KΩ. To set a higher value, calculate the correct value using the following equation: $PWV = V_{Bus} * 100$ <i>PWV</i> : The Pre-Warning value (Ω) <i>V_Bus</i> : The voltage on the measured bus (Volts). For AC, <i>V_Bus</i> should be the peak value (=1.414 x RMS) e.g. If RMS value of the bus voltage is 650VAC, set the pre-warning to: $PWV = 650 * 1.414 * 100$	50-100kΩ
Warning	Critical Fault insulation value - requires immediate attention. The Warning value must be <i>less than</i> the Pre-Warning value. Calculate the correct value using the following equation: $WV = V_{Bus} * 50$ <i>WV</i> : The Warning value (Ω) <i>V_Bus</i> : The voltage on the measured bus (Volts). For AC, <i>V_Bus</i> should be the peak value (=1.414 x RMS) e.g. If RMS value of the bus voltage is 650VAC, set the pre-warning to: $PWV = 650 * 1.414 * 50$	10-100kΩ & <Pre-Warning
V-Delay	Voltage Delay is the time that the voltage must remain below the set value, prior to activation of the Pre-Warning or Warning alarms	2 – 10s
V-PreWarning	Voltage PreWarning: Non-Critical Fault - requires attention. The Voltage Pre-Warning alarm will activate when the measured voltage falls below this value.	0 – 650V
V-Warning	Voltage Warning: Critical Fault - requires immediate attention. The Warning value must be less than the Pre-Warning value.	0 – 650V

Setting	Description	Allowable Values
	The Voltage Warning alarm will activate when the measured voltage falls below this value.	
Enable	Enable or disable the selected channel	Y- Enable N- Disable

4.3.3 Unit Setting Menu

Setting	Description
UNIT ID	Displays the unique ID of the EarthLogger
IP	Displays the IP address of Ethernet; or IP address of 3G/4G
Version	Displays the software version of the EarthLogger
TM	Displays the device Timestamp at the moment when the Unit Setting Menu was selected, noting: <ul style="list-style-type: none"> The date and time displayed may not match local time Timestamp is in the format yyyyymmddHHMM.

4.3.4 Relay Setting Menu

Setting	Description	Allowable Values
Relay Setting	Changes the default mode of the Relays. <ul style="list-style-type: none"> Safe mode: the relay is de-energized by default Non-safe mode, the relay is energized by default 	Safe NonSafe

4.3.5 Password Setting

		Allowable Values
Old Password	Enter the existing password using the numeric method described in 4.2.1	Existing password only
New Password	Enter a new password (Record this number for future reference)	0000-9999
New Password	Re-enter new password to confirm	As above
Save Cancel	Use the Arrow Keys to alternate selection. Press SELECT to finish	Save or Cancel

4.4 TEST & RESET

Function	Action/Response	Comment
TEST	Press TEST to run a Self-Test on the current Channel. A pas result is indicated by: <ul style="list-style-type: none"> Device entering a fault-state Display indicating 10K (+/-2K) 	The test will not begin if the device is in a fault state. The test will halt if: <ul style="list-style-type: none"> An internal fault occurs Connect Bus resistance is or falls below the Pre-Warning value Test times out
RESET	Press RESET to deactivate a PreWarning or Warning	The device will return to a fault state if the fault has not been rectified The device remains in a Fault State even after the fault is removed, This is indicated by an illuminated LED.

4.5 RS485 CONNECTION

Up to four MRD brand ELD devices can be connected using the RS-485 Bus.

- MRD recommends connecting devices using Shielded Twisted Pair Cable
- Ensure that all RS-485-A terminals are connected to one cable only
- Ensure that all RS-485-B terminals are connected to one cable only, not same as RS-485-A
- Ensure all GND terminals are connected to the cable sheath
- If more than three devices are connected, or the cable length is greater than 20m, add a 120Ω resistor as shown below

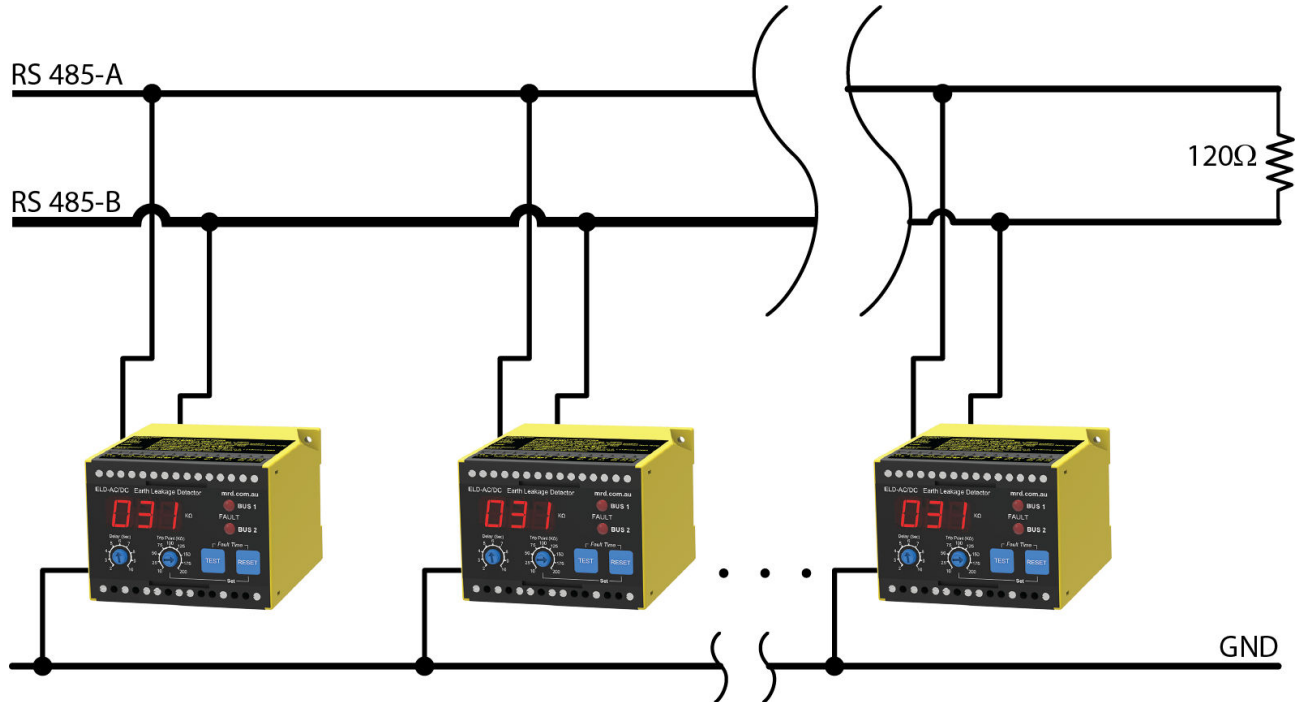

5. EMBEDDED WEB SERVER

EarthLogger includes an embedded Web Server, accessible via a network connection. Use the web server to view the EarthLogger configuration, review logged data and remote Reset/Test the device. The main web server sections are:

- Home page
- View Data and Status
- Download Data
- Debug information
- Configuration (Secure)
- System Upgrade (Secure)

5.1 CONNECT TO THE WEB SERVER

- Obtain the device IP address at the unit: Select Menu> Unit Setting> IP Address>
- Open the IP in your web browser software. EarthLogger supports all major web browsers
- The home page advises Hardware and Software versions, Identifying and Network Settings, and Data options



5.2 LOGIN

Any user can view Settings and Logged Data. Login is required to make configuration or other changes.

To Login:

- Select Login from the side menu
- Enter User name and Password when prompted. Click Login or Press Enter to continue. **Username: User Password: User by default.**
- The Home Screen will now include an extended menu (Config and System Upgrade are added)
- Change Username and Password at Config->LoginConfig

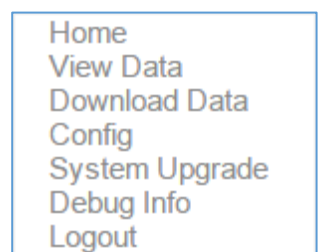
5.3 VIEW DATA

The View Data page enables the inspection of recorded data. There are three tabs: Graph, Data, Test

5.3.1 Graph

Voltage and Insulation Resistance are displayed on separate, aligned charts, and events are colour coded. A typical graph is shown below.

View the status of the channel is displayed. In the event of an Alarm or Warning, the User can Reset or Test the EarthLogger from a remote location.

Data is displayed on time-based graphs. User options are:

- Select the range of data available to display
- Specify the width of display window (Time, x-axis)
- Specify Channel to be viewed
- Zoom in to areas of interest
- Reset Faults on a per-channel basis
- Test the selected channel remotely

The underlying data of the current Channel can be examined:

- Select the Data tab to view the current Channel data in table form
- Select Test to view the tests conducted on the current Channel

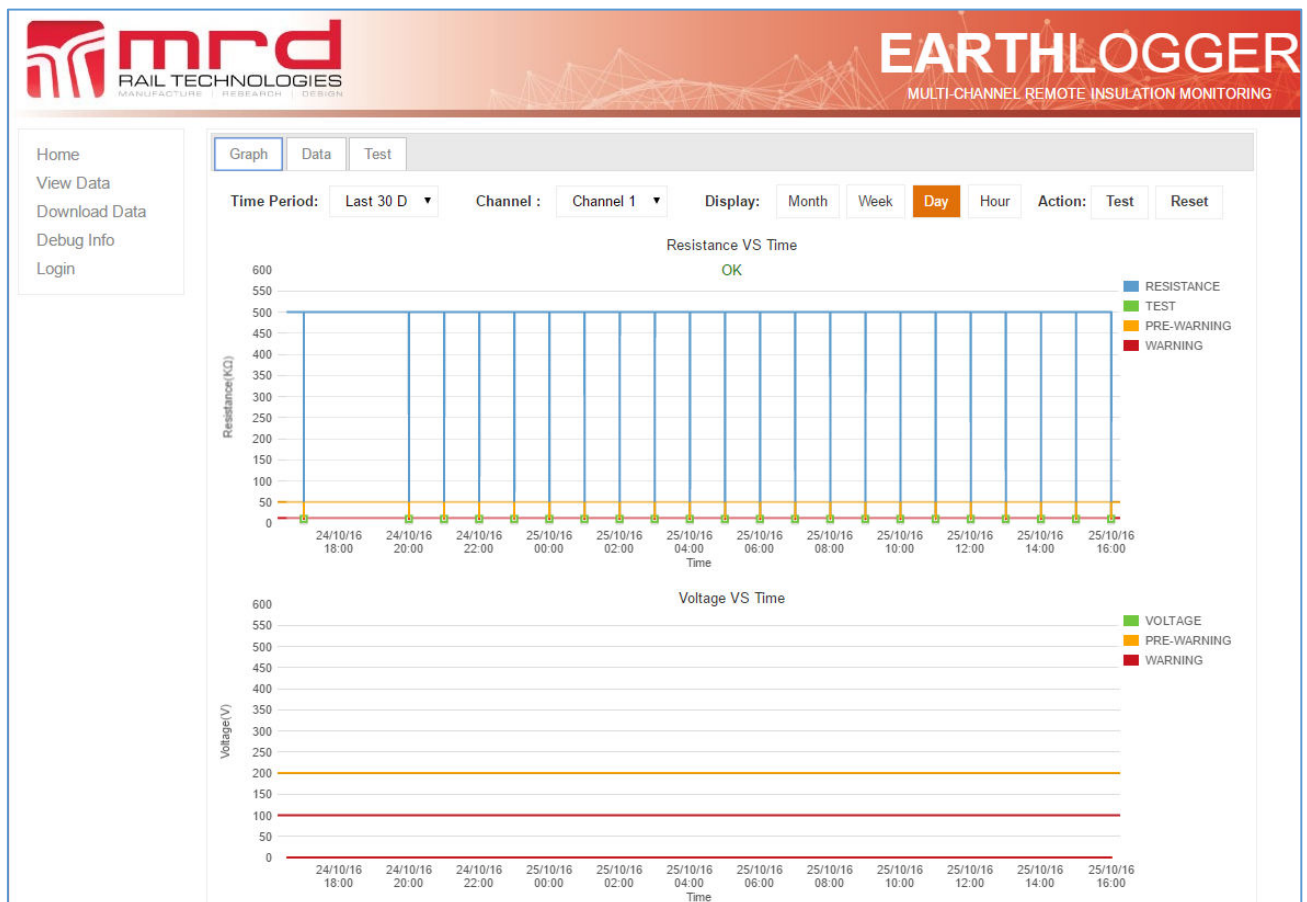

Select areas of interest for closer examination. There are two techniques:

1. Hover the mouse near a node on the graph: an explanatory tip will appear. Generally, nodes represent events and changes.
2. Click and drag to highlight an area of interest: a zoomed-in view of that area will appear.

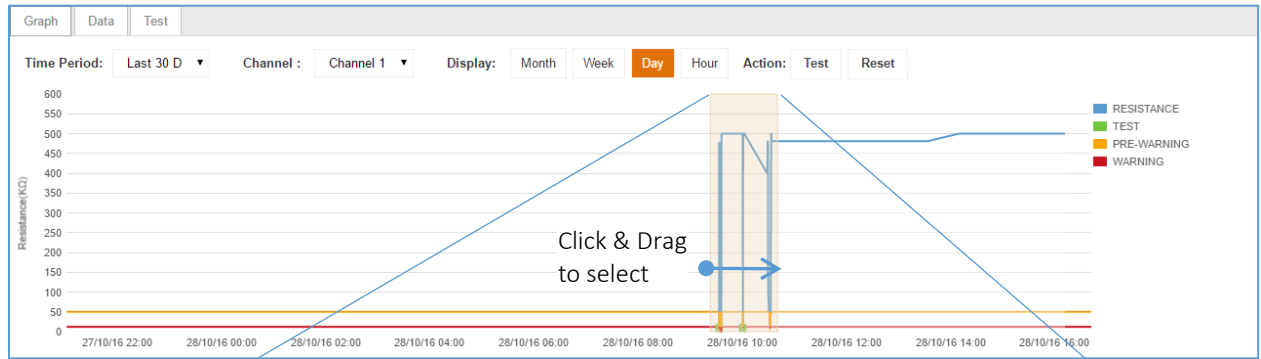

Select Area of Interest

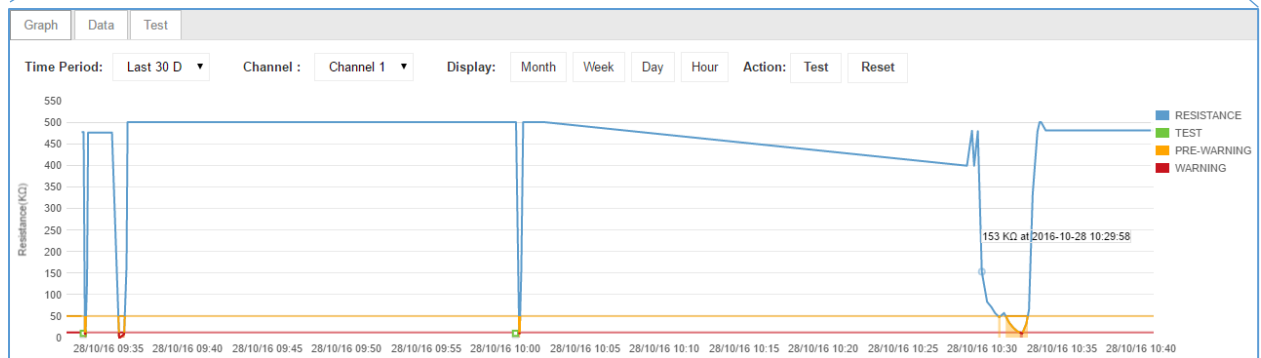

Zoomed View

5.3.2 Data

- The Data points from the current selection on the Graph page are displayed with the most recent result first
- Sort Columns by clicking the Column Header. Click again the reverse the order
- The data set may be large, spanning multiple pages. Use the Page Controls to navigate between pages, and limit the number of records per page
- Click “Export log data” to export all data from the current selection to CSV file (this is same functionality as “download data”, on the side menu. See Section 7.4).

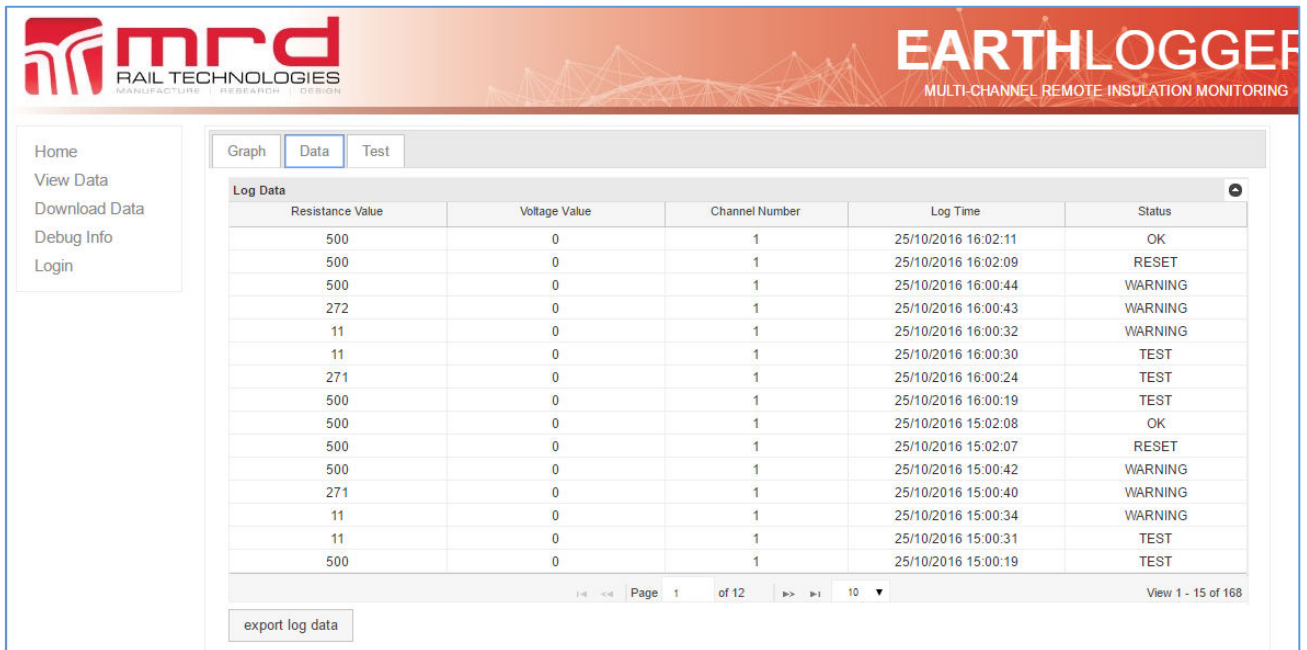

The screenshot shows the EarthLogger interface with the 'Data' tab selected. The 'Log Data' table is displayed with the following columns: Resistance Value, Voltage Value, Channel Number, Log Time, and Status. The table contains 18 rows of data. Below the table, there are navigation controls for pages and records per page, and an 'export log data' button.

Resistance Value	Voltage Value	Channel Number	Log Time	Status
500	0	1	25/10/2016 16:02:11	OK
500	0	1	25/10/2016 16:02:09	RESET
500	0	1	25/10/2016 16:00:44	WARNING
272	0	1	25/10/2016 16:00:43	WARNING
11	0	1	25/10/2016 16:00:32	WARNING
11	0	1	25/10/2016 16:00:30	TEST
271	0	1	25/10/2016 16:00:24	TEST
500	0	1	25/10/2016 16:00:19	TEST
500	0	1	25/10/2016 15:02:08	OK
500	0	1	25/10/2016 15:02:07	RESET
500	0	1	25/10/2016 15:00:42	WARNING
271	0	1	25/10/2016 15:00:40	WARNING
11	0	1	25/10/2016 15:00:34	WARNING
11	0	1	25/10/2016 15:00:31	TEST
500	0	1	25/10/2016 15:00:19	TEST

5.3.3 Test

- The Test Records from the current selection (on the Graph page) are displayed with the most recent result first
- Sort Columns by clicking the Column Header. Click again the reverse the order
- The data set may be large, spanning multiple pages. Use the Page Controls to navigate between pages, and limit the number of records per page

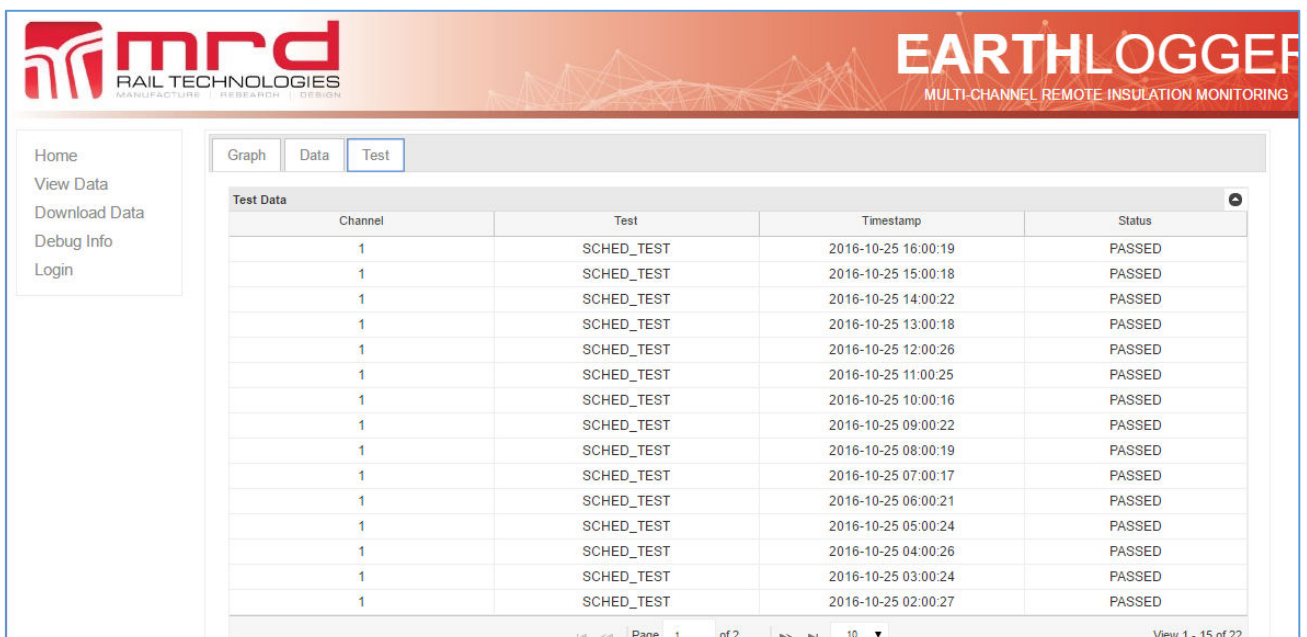

The screenshot shows the EarthLogger interface with the 'Test' tab selected. The 'Test Data' table is displayed with the following columns: Channel, Test, Timestamp, and Status. The table contains 18 rows of data. Below the table, there are navigation controls for pages and records per page.

Channel	Test	Timestamp	Status
1	SCHED_TEST	2016-10-25 16:00:19	PASSED
1	SCHED_TEST	2016-10-25 15:00:18	PASSED
1	SCHED_TEST	2016-10-25 14:00:22	PASSED
1	SCHED_TEST	2016-10-25 13:00:18	PASSED
1	SCHED_TEST	2016-10-25 12:00:26	PASSED
1	SCHED_TEST	2016-10-25 11:00:25	PASSED
1	SCHED_TEST	2016-10-25 10:00:16	PASSED
1	SCHED_TEST	2016-10-25 09:00:22	PASSED
1	SCHED_TEST	2016-10-25 08:00:19	PASSED
1	SCHED_TEST	2016-10-25 07:00:17	PASSED
1	SCHED_TEST	2016-10-25 06:00:21	PASSED
1	SCHED_TEST	2016-10-25 05:00:24	PASSED
1	SCHED_TEST	2016-10-25 04:00:26	PASSED
1	SCHED_TEST	2016-10-25 03:00:24	PASSED
1	SCHED_TEST	2016-10-25 02:00:27	PASSED

5.4 DOWNLOAD DATA

Logged Data can be exported to a Comma Separated Values file on a per-channel basis, within a specified date range. The CSV file contains Unit ID, Insulation Value (Leakage), Voltage, Channel, Timestamp and Status. A sample file is shown below.

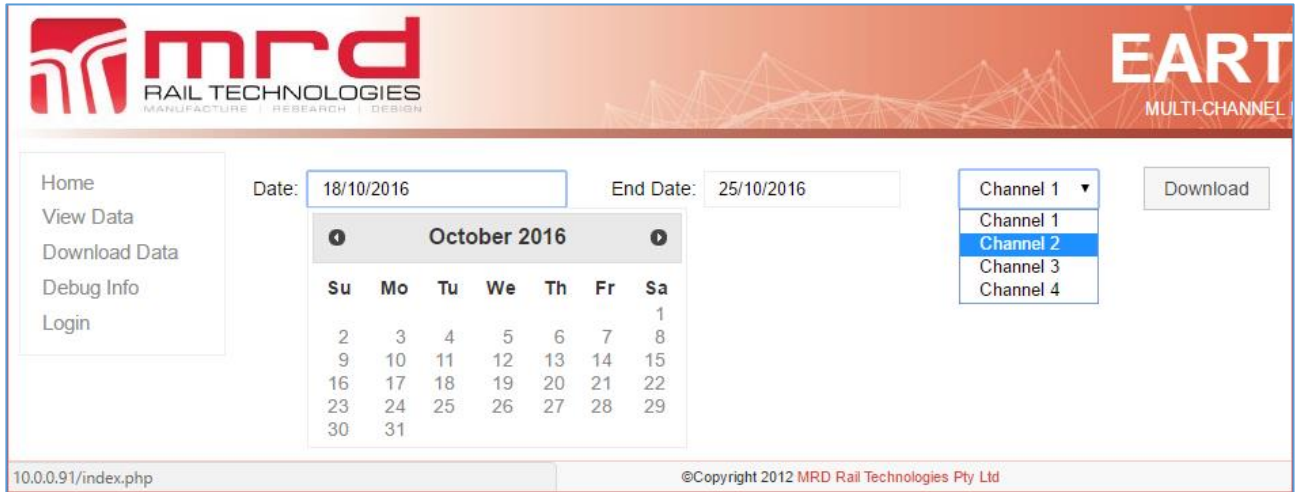

	A	B	C	D	E	F
1	UNIT ID	Leakage	Voltage	Channel	Log Time	Status
65	0000175b4b27	500	0	1	25/10/2016 8:36	SHUT DOWN
66	0000175b4b27	500	0	1	25/10/2016 8:38	OK
67	0000175b4b27	500	0	1	25/10/2016 9:00	TEST
68	0000175b4b27	10	0	1	25/10/2016 9:00	TEST
69	0000175b4b27	10	0	1	25/10/2016 9:00	WARNING
70	0000175b4b27	270	0	1	25/10/2016 9:00	WARNING
71	0000175b4b27	500	0	1	25/10/2016 9:00	WARNING
72	0000175b4b27	500	0	1	25/10/2016 9:02	RESET
73	0000175b4b27	500	0	1	25/10/2016 9:02	OK
74	0000175b4b27	500	0	1	25/10/2016 9:44	SHUT DOWN
75	0000175b4b27	500	0	1	25/10/2016 9:45	OK

5.5 DEBUG INFO

Activity logs are available to trouble shooting problems. To download a log:

- Select "Debug Info". Link icons will appear
- Click the Link of interest, and save to your preferred location
- Open the File from that location.



5.6 CONFIG MENU

5.6.1 EarthLogger Config

Use the EarthLogger Config tab to setup the parameters of each Channel. An explanation of available parameters is included in the table below. To configure a Channel:

- Double Click the required row on the Config table. The “Edit Record” popup will appear
- To select a different Channel without closing the popup:
 - Enter the required Channel # in the Channel field
 - Increase or decrease the channel # using the arrows at bottom left of popup
- Note: Only one channel can be configured per popup opening. Re-open the popup to configure additional channels

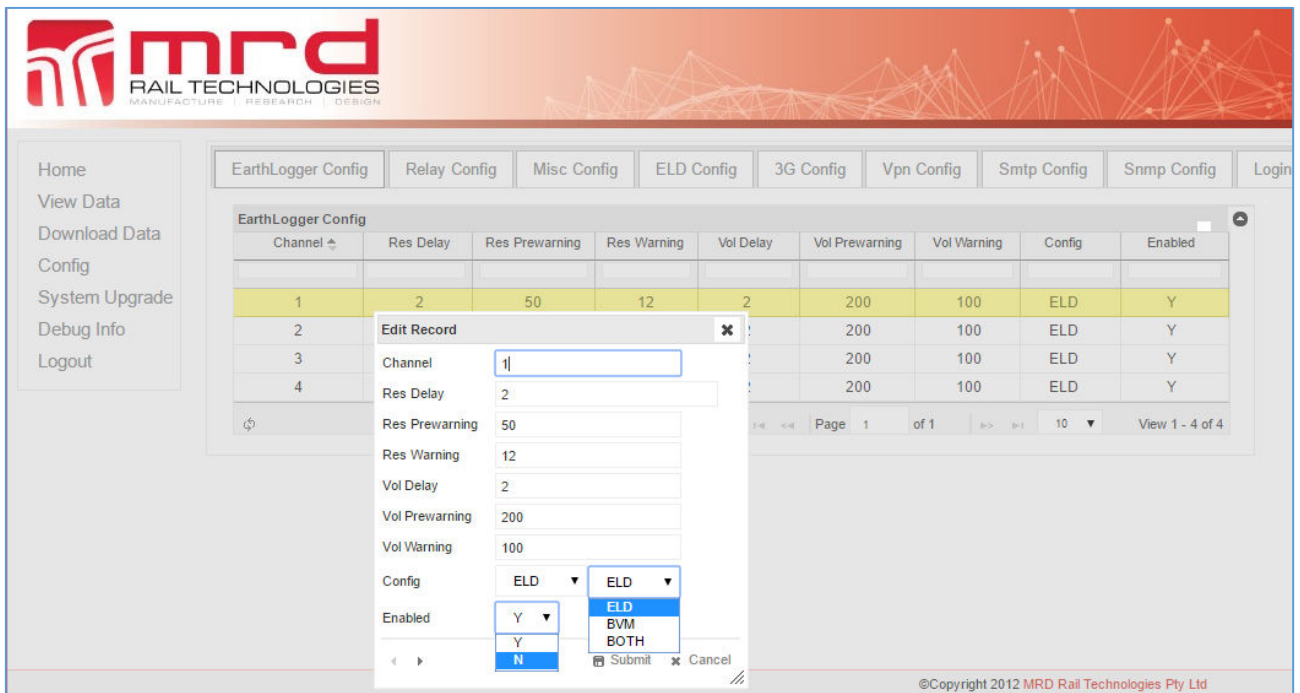

Setting	Description	OK Values
Channel	Represents the channel to be configured. This includes ELDs added in the ELD Config page	1 – 8
Res Delay	The Delay is the minimum period of time that the insulation resistance must remain below the set value, prior to activation of the Pre-Warning or Warning alarms	2-10s
Res Pre-Warning	Non-Critical Fault insulation value (Resistance a.k.a. “Res”) - requires attention. To calculate the recommended minimum value, use the formula at Section 3.3.3	50-100kΩ & >Warning
Res Warning	Critical Fault insulation value - requires <i>immediate</i> attention. To calculate the recommended minimum value, use the formula at Section 3.3.3	10-100kΩ & <Pre-Warning
Voltage Delay	Voltage Delay is the minimum period of time that the voltage must remain below the set value, prior to activation of the Pre-Warning or Warning alarms	2 – 10s
Voltage Pre-Warning	Non-Critical Fault voltage value - requires attention: The Voltage Pre-Warning alarm activates when the measured voltage is below this value.	0 – 650V
Voltage Warning	Critical Fault voltage value - requires immediate attention: must be < Pre-Warning. The Voltage Warning alarm activates when the measured voltage is below this value.	0 – 650V
Config	There are 3 modes available for each channel: ELD – Only insulation resistance is monitored BVM – Only voltage is monitored BOTH – Both insulation resistance and voltage are monitored	ELD BVM BOTH
Enable	Enable or disable the selected channel	Y- Enable N- Disable

5.6.2 Relay Config

EarthLogger is fitted with two relays able to control external devices such as Audible Alarms. Rules control when each Relay is activated.

Relay Config	Select the Relay to be configured. <i>Note: The current Relay Settings will be saved immediately if any changes have been made</i>
Select Channel	Select the Channels which may activate the current Relay
Select Warning or PreWarning	Select which Alarm State will activate the current Relay
Select Voltage or Resistance	Select which measured parameters will activate the current Relay
Submit	Click Submit to save settings for the current Relay

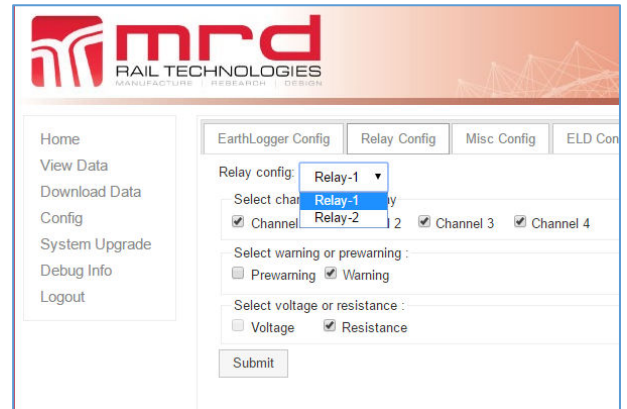

5.6.3 Misc Config

5.6.3.1 IP settings

By default, EarthLogger obtains a network IP address from the DHCP server, when power is connected.

To configure a Static IP address:

- Obtain required settings from your network administrator
- Select Static IP from the drop down list
- Enter required values in the IP Address, Netmask, Gateway and DNS1 fields
- DNS2 field is optional

5.6.3.2 Time

To automatically update time:

- Specify a NtpServer to synchronise time
- Timezone, Date and time fields will autopopulate

To set time manually:

- If necessary, clear the NtpServer field
- Select the required Timezone from the drop down list
- Enter today's date in DD/MM/YYYY format
- Enter the time in 24 hour format (HH:MM)

5.6.3.3 Email Notifications

- EarthLogger can generate automatic notifications for Alerts and Warnings.
- Enter a valid destination email address. Note: EarthLogger does not test that the address is valid.

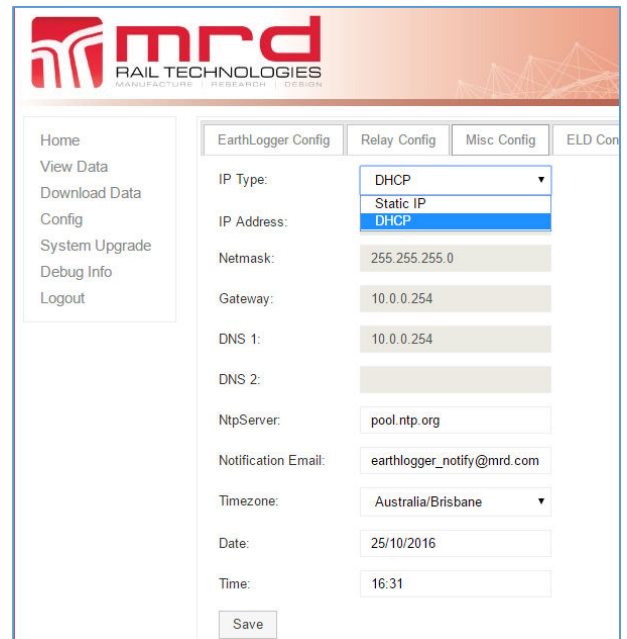

5.6.4 ELD Config

Extra ELDs units can be logged using the RS-485 communication bus.

This function can be enable/disable as well as change unit ID. Notice that to make sure there is only one unit connected to the RS485 when using Set ELD Id function. Status of the connected units are displayed at this page.

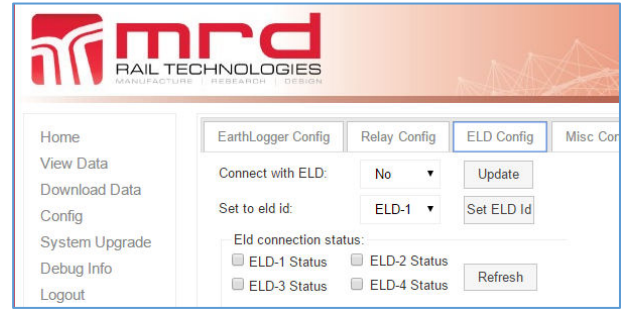

5.6.5 3G Config

Enable or disable the internal 3G/4G module using the Auto connect field. Internet Server must match the SIM card carrier inserted in the unit.



5.6.6 VPN Config

The VPN function provides remote access the embedded webservice, using a PPTP connection and encryption. The following fields are to be completed:

Field	Description
VPN Service	VPN connection name
VPN Server	Server's name or IP address to connect
Login account	User name provide by the VPN provider
Password	Password provided by the VPN provider
VPN Network	VPN network IP range
VPN Netmask	VPN network Netmask
VPN Gateway	VPN Network Gateway
Auto Connect	Disable/ enable VPN connection

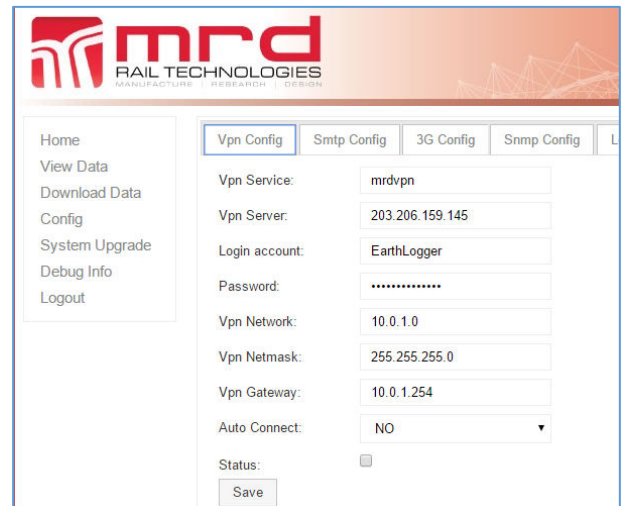

5.6.7 SMTP Config

EarthLogger uses SMTP to send email alerts.

- Request an email account from your network administrator
- Obtain account settings and enter in the appropriate field
- Click Save

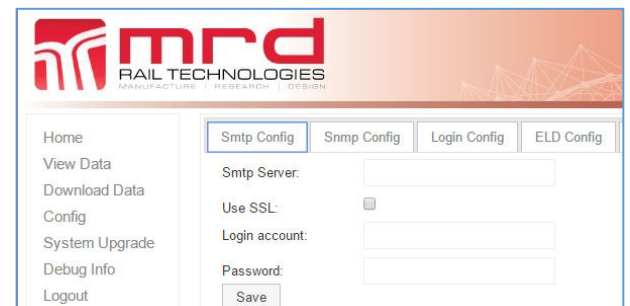

5.6.8 SNMP Config

Simple Network Management Protocol is an IP for collecting and organizing information about managed devices on IP networks and for modifying that information to change device behaviour.

To Config SNMP:

- Obtain settings for your network administrator
- Enter the settings in the appropriate field and click Save



The screenshot shows the 'Snmp Config' tab in the MRD web interface. It includes a navigation menu on the left with options like Home, View Data, Download Data, Config, System Upgrade, Debug Info, and Logout. The main content area has tabs for Snmp Config, Relay Config, Misc Config, and ELD Config. Under the Snmp Config tab, there are three input fields: 'Read Community Name', 'Trap Community Name', and 'New Trap Address'. A 'Save' button is located at the bottom right of the form.

5.6.9 Login Config

Use this tab to redefine the Username and Password required to make changes to the Web Server or EarthLogger configuration.

- Username is restricted to 30 characters
- Password must be minimum 4 characters

Note: This does not affect the Password required to direct access the device using the OLED display.

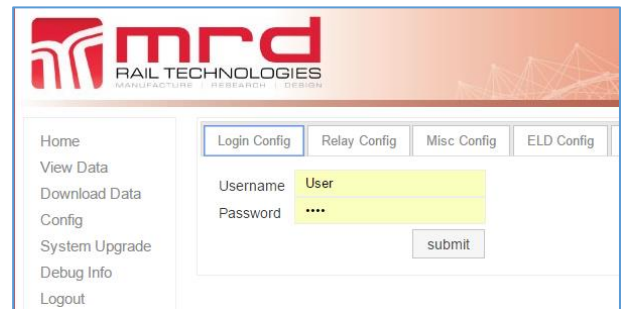

The screenshot shows the 'Login Config' tab in the MRD web interface. It includes a navigation menu on the left with options like Home, View Data, Download Data, Config, System Upgrade, Debug Info, and Logout. The main content area has tabs for Login Config, Relay Config, Misc Config, and ELD Config. Under the Login Config tab, there are two input fields: 'Username' (with the value 'User') and 'Password' (with masked characters '****'). A 'submit' button is located at the bottom right of the form.

5.7 SYSTEM UPGRADE

There are 4 upgrades:

- Firmware Management: upgrades the EL4+ low level firmware
- Application Management: upgrades the unit applications
- Web Management: upgrades the embedded web server
- System Management: upgrades the whole system.

No downgrades are available.

5.7.1 Firmware Management

This page enables an authorised user to Select, Upload and install a Firmware Version.

Warning: DO NOT change firmware unless specifically instructed by MRD. Only use the file supplied by MRD (*.hex).

To change firmware:

- Choose firmware file from a network location
- Click Upload. The firmware installation process will begin. A typical installation requires less than three minutes, depending on Network speed.

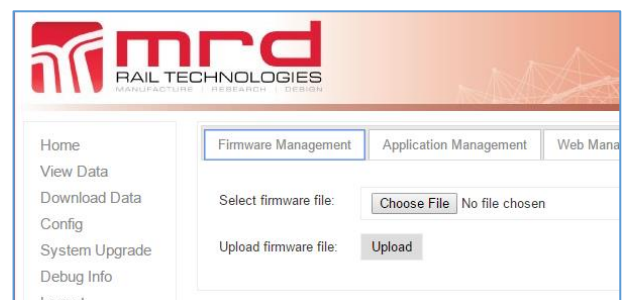

The screenshot shows the 'Firmware Management' tab in the MRD web interface. It includes a navigation menu on the left with options like Home, View Data, Download Data, Config, System Upgrade, Debug Info, and Logout. The main content area has tabs for Firmware Management, Application Management, and Web Management. Under the Firmware Management tab, there are two input fields: 'Select firmware file:' with a 'Choose File' button and 'No file chosen' text, and 'Upload firmware file:' with an 'Upload' button.

5.7.2 Application Management

Use this tab to upgrade the embedded Application Software, which controls the EarthLogger on-screen display.

To change the Application Software:

- Choose Application file from a network location (MRD_EarthLogger_App_”version”.tar)
- Click Upload. The server installation process will begin. A typical installation requires less than one minute to complete
- Turn supply power OFF/ON. It may take several minutes for the device to reboot.



5.7.3 Web Management

Use this tab to upgrade the Embedded Web Server.

To upgrade the Embedded Web Server:

- Choose firmware file from a network location (MRD_EarthLogger_Web_”version”.tar)
- Click Upload. The server installation process will begin. A typical installation requires less than one minute to complete

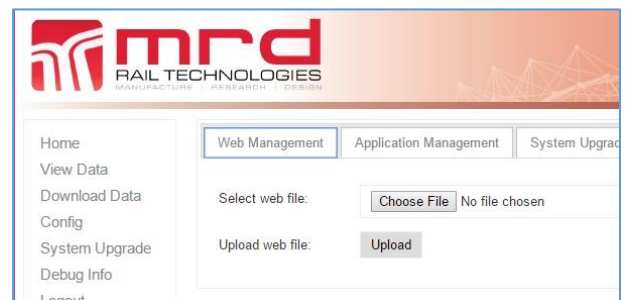

5.7.4 System Upgrade

This option upgrades the entire EarthLogger device software, including:

- Embedded Application
- Embedded Web Server

Firmware, configuration and logged data are not affected.

To upgrade the system:

- Choose the Package File supplied by MRD (MRD_EL4_”version”.tar.gz)
- Click Upload. A typical installation requires less than five minutes to complete. Ensure power is available during entire process.

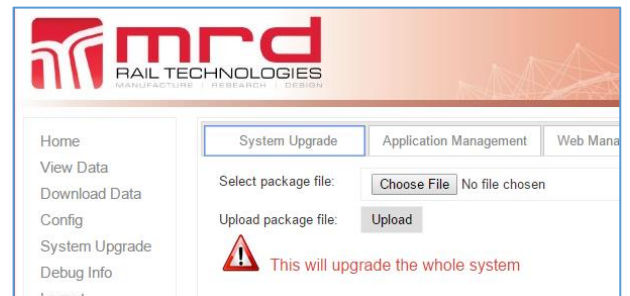

6. WARRANTY

Congratulations on choosing an MRD EarthLogger. MRD Products are designed and manufactured to the highest standards, and backed with a TWO YEAR Warranty covering materials or manufacturing defects, commencing on the date of customer receipt.

Please record your product details below.

Model	Serial Number	Date of Purchase	Supplier
EL4+	_____	___/___/20___	

Conditions

MRD warrants your new EarthLogger EL4+ shall be free of material or manufacturing defects and shall operate as designed, when installed, used, and maintained according to the EL4+ Installation Guide, Technical Data Sheet, and User Manual.

This warranty does not cover:

- Normal wear and tear
- Problems not caused by materials or manufacturing defects
- Damage caused in-transit, by fluid ingress, by accident, or intentionally
- Damage resulting from installations or applications not expressly approved by MRD
- Devices that are altered in any way, including software or removal of the serial number
- Any other event, act, default or omission beyond MRD's control.

In the event of a possible warranty claim, immediately **stop using the device and contact your supplier for assistance**. It may be possible to solve the problem without returning the device.

Returns

Do not return the device unless authorised by your supplier. If a return is required, it is your responsibility to pack the device for safe shipping, and to ship the device as instructed by your supplier. Return shipping is at your expense.

MRD will inspect returned devices. We will repair or replace devices or parts of devices that are found defective due to material or manufacturing faults. We will quote to repair other problems, if requested. We will return devices determined to be No Fault Found, at your expense.

Limited Liability

The benefits provided by this warranty are in addition to other rights and remedies available to the consumer under the law. In no instance shall MRD be liable for consequential damages.

For Australia Only

MRD Rail Technologies Pty Ltd goods come with guarantees that cannot be excluded under the Australian Consumer Law. You are entitled to a replacement or refund for a major failure and compensation for any other reasonably foreseeable loss or damage. You are also entitled to have the goods repaired or replaced if the goods fail to be of acceptable quality and the failure does not amount to a major failure.

	<p>This warranty is offered by: MRD Rail Technologies Pty Ltd 235 South St, Cleveland. QLD. 4163. Australia. +61 7 3821 5151 support@mrd.com.au</p>
---	--

END OF MANUAL