

ESM1 User Manual

ESM1-A AC Power Supply

ESM1-B DC Power Supply



Publication History

Version	Released	Comment	Status
1.0	04Jul16	Advance issue for evaluation	Withdrawn
1.1	23Aug16	Issued for distribution	Superseded
1.2	04Apr17	7.1 Modbus protocols table updated	Superseded
1.21	07APR17	Reorganised. 6.1 Modbus protocols table updated	Superseded
1.30	01Jun17	Changes to interface; hysteresis response explained; Application notes added; Appendix 3 added (Wiring diagrams);	Superseded
1.4	24Jul17	Appendix 3 drawings updated	Superseded
1.5	08/10/19	Added Relay Default Contacts	Superseded
1.6	07/12/20	Fixed relay contacts	Superseded
1.7	09/12/20	Added Test Earth information	Superseded
1.8	06/01/21	Updated Leakage Values	Superseded
1.9	05/03/21	Added wiring diagrams to appendix	Superseded
1.10	06/11/23	Changed Relay Pins to match diagram	Superseded
1.11	15/10/24	Added default settings and basic operation	Superseded
1.12	04/02/25	Updated warranty information	Active

EarthSense™ ESM1 User Manual

MRD provides the embedded software described in this manual under license agreement: it may be used only in accordance with the terms of that agreement.

Trademarks

The MRD logo is registered trademark of MRD Rail Technologies Pty Ltd.

All other trademarks or registered marks in this manual belong to their respective holders.

Disclaimer

Information in this document is subject to change without notice and does not represent a commitment on the part of MRD Rail Technologies Pty Ltd.

MRD provides this document as is, without warranty of any kind, expressed or implied, including, but not limited to, its particular purpose. MRD reserves the right to make improvements and/or changes to this manual, or to the products and/or the programs described in this manual, at any time.

MRD intends that the Information in this manual is accurate and reliable. However, MRD assumes no responsibility for its use, or for any infringements on the rights of third parties that may result from its use. This manual, and the product it relates to, might include unintentional technical or typographical errors. From time to time, MRD corrects such errors, and these changes are included in the latest version.

Copyright Notice

© 2024 MRD Rail Technologies Pty Ltd. All rights reserved.

Conventions used in this document

Operation instruction sequences are in the form:

XXXX>xxxx>yyyy>

- XXXX is a Button Press (XXXX is the on-screen button label)
- xxxx & yyyy are Menu items selected using ▼ & ▶

Multi-row screen shots are sequenced as shown at right.

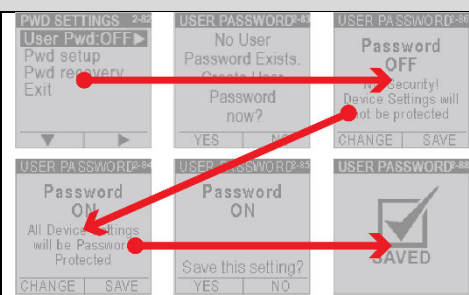

Technical Support

Manufacturer	MRD Rail Technologies Pty Ltd	
Address	235 South St, Cleveland. QLD. 4157	
Telephone	+61 7 3821 5151	
Email	support@mrd.com.au	
Web	www.mrd.com.au	
Downloads	User Manual	www.mrd.com.au/dl/esm1-UM.pdf
	Datasheet	www.mrd.com.au/dl/esm1-DS.pdf
	Installation Guide	www.mrd.com.au/dl/esm1-IG.pdf
	Wiring Diagram	www.mrd.com.au/dl/001.pdf

Table of Contents

1. INTRODUCTION	4
2. PRODUCT DESCRIPTION	4
2.1 Insulation Monitoring	4
2.2 Application notes	5
2.3 External Communications/Activations	5
2.4 Notes on Trip Delay, Hysteresis and Automatic Reset	6
2.5 User Authentication	7
2.6 Insulation Resistance- Principle of Measurement	7
3. BASIC INSTALLATION.....	7
3.1 Installation Notes.....	7
3.2 Required Connections	7
3.3 Optional Connections	8
3.4 AC Bus Connection Diagram ESM1-001.....	8
3.5 DC Bus Connection Diagram ESM1-001.....	8
4. SETUP AND OPERATION.....	9
4.1 Interface.....	9
4.2 Default Settings	10
4.3 Basic Operation.....	11
4.4 Self-test.....	12
4.5 Passwords (Authentication).....	13
4.6 Warning Settings.....	14
4.7 Alarm Settings.....	15
4.8 Relay States.....	16
4.9 RS485 Communication.....	16
5. RS485 COMMUNICATIONS	17
5.1 MODBUS Protocols	17
5.2 Connection diagram	18
6. APPENDICES.....	19
A1 Technical Datasheet.....	20
A2 Warranty.....	21
A3 Wiring Diagrams	22

1. INTRODUCTION

This document provides information on the specification, application, installation and operation of the EarthSense ESM1 Insulation Resistance Monitor.

There are two ESM1 variants, identical other than power supply requirements

- ESM1-A AC Power Required (85-264 Volts AC, 50-60Hz)
- ESM1-B DC Power required (9.6-36 Volts)

2. PRODUCT DESCRIPTION

2.1 INSULATION MONITORING

The ESM1 monitors the Insulation Resistance (IR) of an attached circuit and alerts system operators if the IR falls below a user-selected trip value for longer than a pre-set period. Alert devices are:

- On-screen display
- LED colour
- Relay operation to activate external equipment
- External communication using an RS485 connection.

There are two User selectable trip values, R_{AN1} and R_{AN2} , referred to as Warning and Alarm. The Warning value must always be greater than the Alarm. In the event of an alert, until Reset, the device will:

- Continue to monitor and display the current IR value
- Display the highest recorded alert State (Warning or Alarm)
- Display the lowest IR value recorded
- Count and Display the number of hours since alert started
- If the alert state continues beyond the Trip Delay period
 - Change LED colour
 - Activate Relay(s)

Warning and Alarm have the following settable parameters, available at all times except during self-test:

- Trip (Response) Value ($k\Omega$)
- Trip Delay (seconds)
- Relay Activated (1 or 2)
- Activated Relay State (Normally Open or Normally Closed)

Reset are done manually (on the device) or remotely (using RS485 or a connected reset switch), or the device can be configured to Auto-Reset if the IR increases above the Warning value.

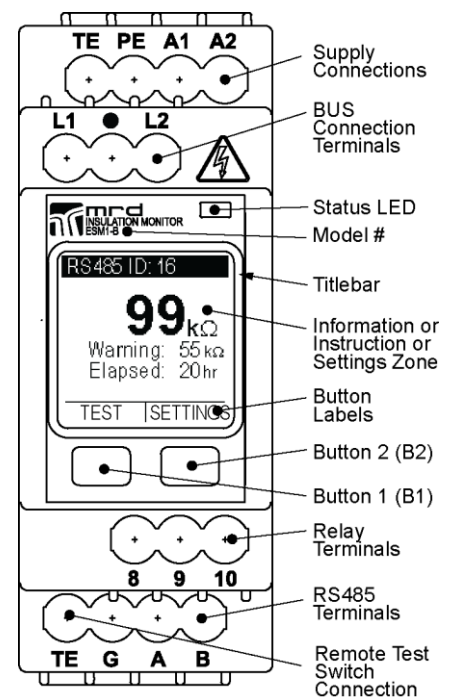

2.2 APPLICATION NOTES

The ESM 1 was designed to measure insulation resistance in IT Systems (isolated from earth). The ESM1 can be used in mixed AC/DC networks.

DO NOT CONNECT DEVICES IN PARALLEL!

The ESM1 generates adaptable square wave pulses at very low frequency, preventing disturbance earth capacitances and DC offset currents. Using 2 or more units on one bus bar will disrupt insulation resistance measurement.

The ESM1 can monitor many types of IT Systems. For applications not listed below, contact MRD for advice. Appendix 3 includes wiring diagrams for the following types of IT System:

- 2-wire DC
- 3-Wire DC
- 2 Wire AC
- 4 Wire AC
- 3 Wire AC

2.3 EXTERNAL COMMUNICATIONS/ACTIVATIONS

The ESM1 uses two relays, which can activate external devices such as buzzers and lights, or connect to PLCs.

The ESM1 uses a configurable RS485 connection for bi-directional communication. Parameters are:

- RS485 Identification Number (01-99)
- Baud rate (from Preset List)
- Parity (None, Even, Odd)

Sections 4.7, 5.1 and 5.2 provide guidance for RS485 connection and configuration.

2.4 NOTES ON TRIP DELAY, HYSTERESIS AND AUTOMATIC RESET

Noise and small fluctuations may cause unprotected devices to respond in an undesirable manner, creating false alarms and possibly damaging the unit. In particular, noise near R_{AN} might cause excessive tripping of Relays when Auto-Reset is enabled. ESM1 limits the effect of noise and small fluctuations in three ways.

2.4.1 Variable Trip Delay

The Warning and Alarm activation is conditional on the Insulation resistance being below the trip value for up to 20 seconds. This reduces the number of false alerts.

2.4.2 AutoReset.

Turn Auto-Reset OFF to cause Warnings and Alarms to latch until reset.

2.4.3 Hysteresis effect

A hysteresis effect is added to the ESM1, to stabilise responses following the latching of a Warning or Alarm. If AutoReset is ON, the hysteresis prevents excessive switching in noisy environments.

When latched, Insulation Resistance must rise by the greater of $1k\Omega$ or 10% of R_{AN} , before RESET is permitted.

Increasing trip delays does not affect the exit time from Warning or Alarm states: this occurs immediately if the Insulation Resistance rises above the relevant hysteresis level. The diagram below shows the ESM1 response characteristic, assuming Trip Delays are zero.

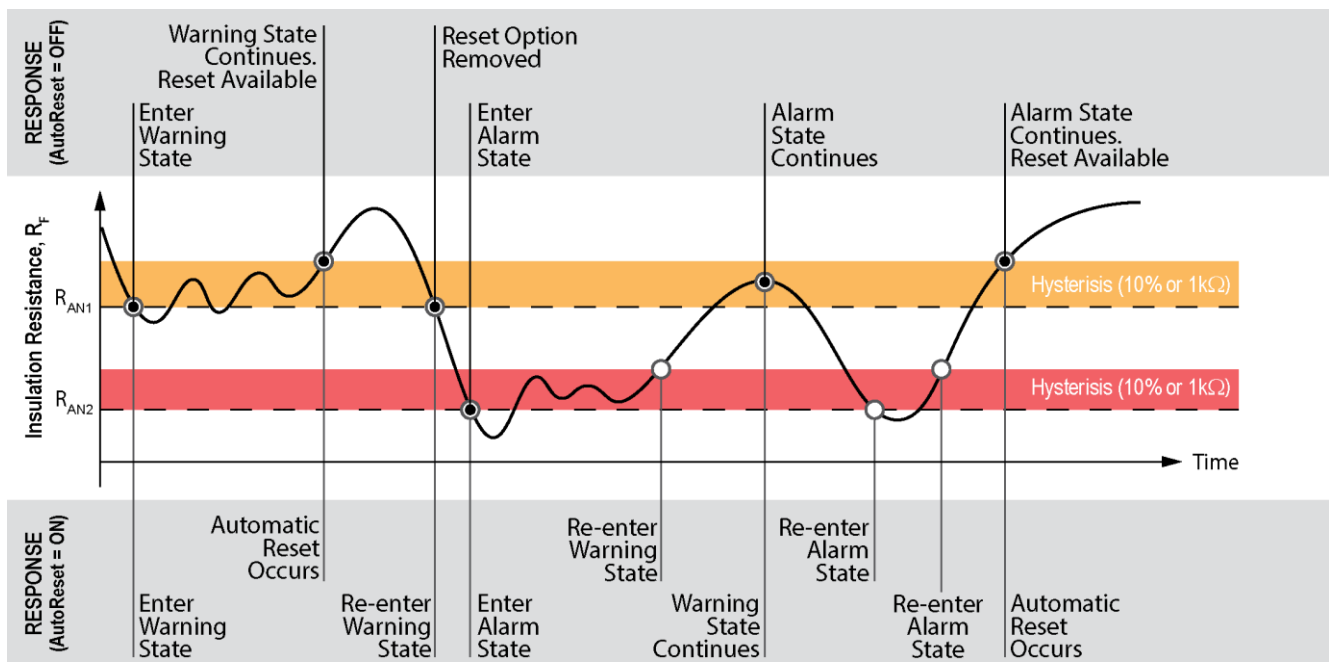

2.5 USER AUTHENTICATION

The device uses two Passwords to authenticate users and control ability to change device Settings. Passwords are not required to view device status or current Settings. Authentication is optional. If Authentication is ON:

- The Factory Password is required to recover from a lost User Password.
- The User Password is required to change Device Settings. This password is User defined.

2.6 INSULATION RESISTANCE- PRINCIPLE OF MEASUREMENT

The ESM1 measures Insulation Resistance using the current measuring principle. The Equivalent Circuit is shown at right, where R_F = Insulation Resistance and R_i = Internal Impedance.

The ESM1 injects a polarity switching DC current into the attached Bus. Fault current is measured and used to calculate the Insulation Resistance (R_F), as shown below. The Equivalent Circuit is shown at right.

$$R_F = \left(\frac{V_m}{I_m} \right) - R_i$$

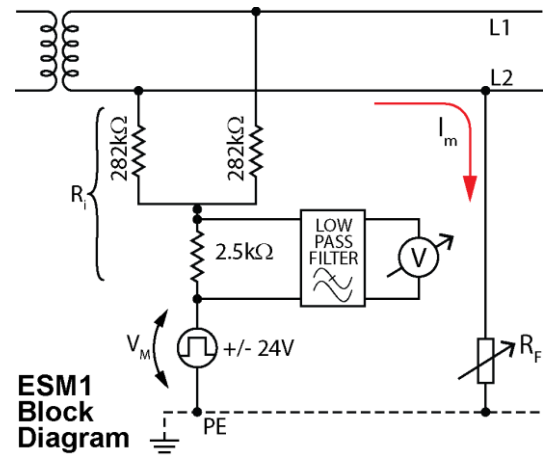

3. BASIC INSTALLATION

3.1 INSTALLATION NOTES



- Refer to ESM1 Installation Guide available at: www.mrd.com.au/dl/esm1-IG.pdf
- Refer to Wiring Diagram ESM1-0001, and Appendix 3
- DO NOT CONNECT DEVICES IN PARALLEL
- Extra care is required when connecting Bus cables to the device. DO NOT allow Bus Connector wires to touch any terminal other than L1 and L2: the device will be damaged
- MRD recommends that device is connected to de-activated bus
- Use appropriate Personal Protective Equipment when handling live connections
- The device snap fits to a standard 35mm DIN Rail ❶ ❷
- Use an insulated, flat-blade screwdriver to tighten terminals or release the DIN Rail Clip ❸
- Tighten terminals to 0.5-0.6nm. Ensure all connections are tight before use

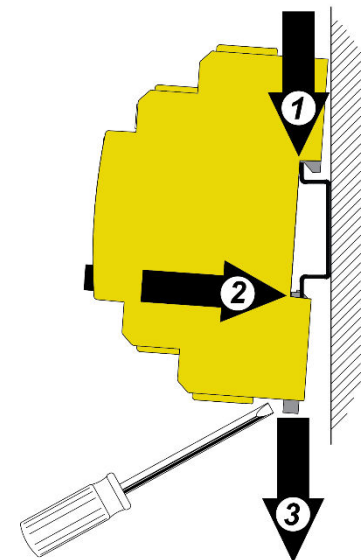

3.2 REQUIRED CONNECTIONS

Installation type	AC Bus	DC Bus
Bus	<ul style="list-style-type: none"> • Connect AC Bus to L1 and L2 	<ul style="list-style-type: none"> • Connect DC Bus to L1 and L2
Earth	<ul style="list-style-type: none"> • Connect Earth to PE & TE using separate cables • Test Earth Connections 	
Power Supply	<ul style="list-style-type: none"> • Connect supply voltage to A1 & A2. DC supply must observe polarity • Use an in-line 2A fuse 	

3.3 OPTIONAL CONNECTIONS

Test/Reset	<ul style="list-style-type: none"> Connect an external Test/Reset switch to terminal TR & G, if required
Relays	<p>Connect Relay Activated External devices</p> <ul style="list-style-type: none"> Relay 1- Connect device to terminals 9 (K1) & 8, if required (maximum rating 3A @ 240V) Relay 2- Connect device to terminals 10 (K2) & 8, if required (maximum rating 3A @ 240V) <p>The unit does not supply power to the relay contacts.</p>
RS485 Comm's	<p>Connect RS485 Communications (<i>Recommended: RS485 Shielded Twisted Pair cable, size AWG22 or AWG24</i>)</p> <ul style="list-style-type: none"> Connect RS485 Cable to Terminals A & B Connect RS485 shield to terminal G Connect RS485 120Ω Termination Resistor if required See Section 6 for connection diagram
Test Earth (TE)	<p>For safety, the ESM1 supports a test earth as well as the main earth. This allows for the earth continuity self-test (explained in section 4.2) to also monitor the earth connection to ensure all leakage measurements are accurate. This is the recommended setup to ensure a good earth connection.</p> <p>To implement this, use a separate test earth stake, and connect to terminal TE. Connect the main earth to terminal PE.</p>

3.4 AC BUS CONNECTION DIAGRAM ESM1-001

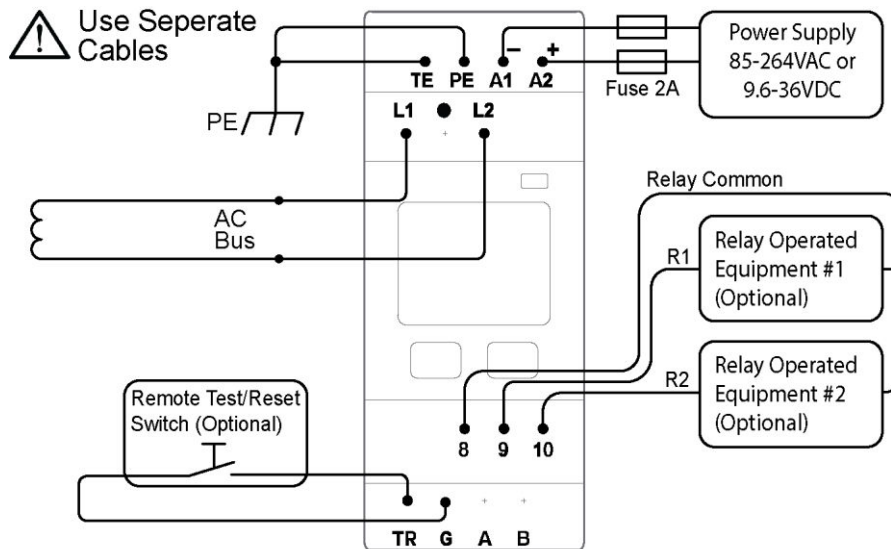

3.5 DC BUS CONNECTION DIAGRAM ESM1-001

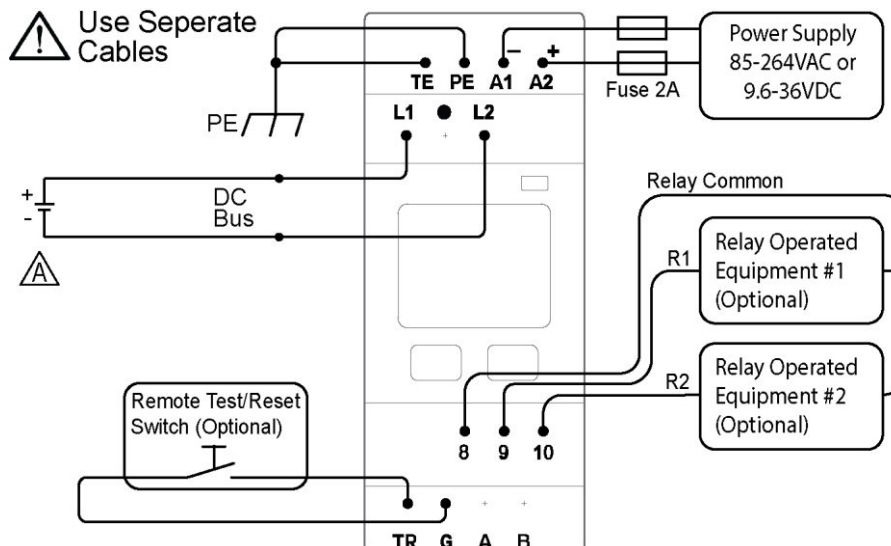

4. SETUP AND OPERATION

4.1 INTERFACE

The ESM1 features a high-resolution, sunlight-readable LCD display, two buttons, and one tri-colour LED. Remote interfaces are also available using connected devices and or RS485 communications. Primary control uses the screen and buttons.

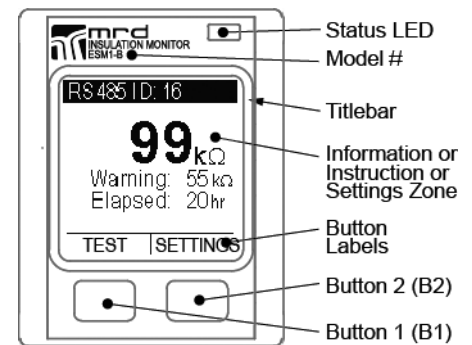

4.1.1 LCD Screen

Other than in Self-Test mode, the screen is divided into Title Bar zone; Settings zone; Button Label zones. Some screens will also contain information and or instructions.

The on-screen menus have been designed for simple navigation and operation, using a two-button interface. All menus, option lists, and value selectors are ‘circular’: repeated pressing of ▼ or ▲ will continuously scroll through the options.

Note: There are no “Back” or “Undo” options. You can only go forward through a process. If an error is made use ► to advance through the menu until a Do-Not-Save or Exit opportunity appears. The device always requests confirmation before saving changes.

4.1.2 Buttons

The functions of the buttons vary, and this is indicated by the on-screen labels. The buttons activate on release. No long, combination or sequential presses are required to operate the device.

B1 Label	Action
▼	Highlights the next item in the menu
▲	Changes the highlighted value by 1 or Scrolls through options
CHANGE	Opens the related Change Screen
YES	Answers “YES” to an on-screen question
TEST	Starts the device Self-Test
RESET	Clears error state records from memory

B2 Label	Action
►	Select the highlighted item
SETTINGS	Opens the Device SETTINGS menu
SELECT	Saves the highlighted value
NO	Answers “NO” to an on-screen question
EXIT	Returns to the Parent Screen

4.1.3 Tri-Colour LED



An RGB LED communicates and emphasises the device status. The LED modes are:

Colour	Device Status
None	No Power Supply. The device is not working.
GREEN	OK. Device is monitoring Insulation Resistance properly
RED	Warning State: Insulation Resistance has fallen below the Warning Trip Value, R_{an1}
RED FLASHING	Alarm State: Insulation Resistance has fallen below the Alarm Trip Value, R_{an2} ; or Device is latched following self-test; or Device has failed Self-Test (see LCD display)
BLUE	Self-Test in Progress, or Device is in SETTINGS mode
PURPLE	Firmware Upgrade in progress

4.1.4 Entering Numeric Values

Trip Values and RS485 Identities are entered as individual digits. If a low value is required, leading zeros must be used e.g. 06=6; 006 = 6; 067=67.

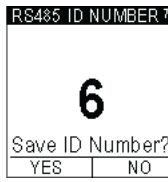

A change page initially displays the current value with the first digit highlighted. Working from left to right, digits are selected from a 0-9 scrollable list, before moving to a confirmation page.

<p>Change a Numeric value</p>	<ul style="list-style-type: none"> Use ▲ to select a value for the highlighted digit Use ► to highlight the next digit to the right, or go to the confirmation page Confirmation page displays numeric value to be saved, and requests permission to save the value 			
-------------------------------	--	--	---	---

4.1.5 Entering or Changing Password Values

Passwords are stored as three digit codes, not numbers. The device never reveals the current password.

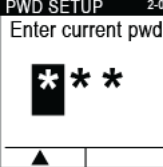
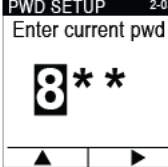
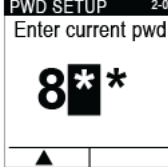
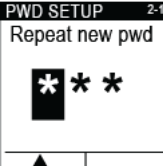
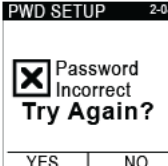
You can only go forward through the password process. If a mistake is made or if you accidentally enter the Change page, use ▲ and ► to advance to the Try Again? Page.

Function	Comments	Sample Pages		
<p>Enter or Change a Password value</p>	<ul style="list-style-type: none"> Instructions are on-screen All Enter Password pages initially display *** Use ▲ to select a value for the highlighted digit (mandatory) Use ► to highlight the next digit to the right, or go to the next page If the operator attempts to save an invalid or non-matching value, the device will offer the opportunity to Try Again A message confirms successful completion of a change 			
				



4.2 DEFAULT SETTINGS

The default settings of the ESM1 are outlined in the table below.

Function	Settings
Warning	<ul style="list-style-type: none"> Trip Value: 200kΩ Trip Delay: 1 second Relay: 1 Relay Type: Normally Open
Alarm	<ul style="list-style-type: none"> Trip Value: 50kΩ Trip Delay: 2 seconds Relay: 2 Relay Type: Normally Open
RS485	<ul style="list-style-type: none"> ID: 1 Baud Rate: 19200 Parity: None
Other	<ul style="list-style-type: none"> Auto-Reset: Off

4.3 BASIC OPERATION

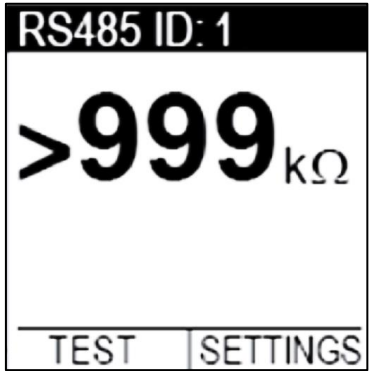
The table below shows some situations, in order from least priority to highest priority, with the response of the ESM1 listed. This is based on the default settings of the device listed in section 4.2.

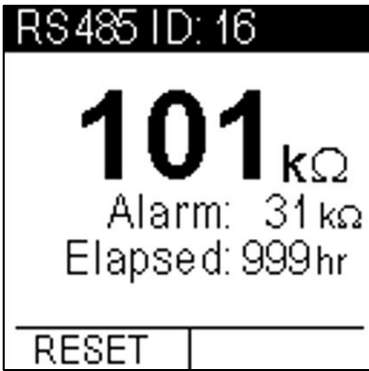
Situation	Response (Default Settings)	Image
No warning or alarm: Earth leakage detected is above the warning threshold	<ul style="list-style-type: none"> • Display shows current earth leakage • LED is solid green • Left push button shows “Test” option • Both K1 (8 and 9) and K2 (8 and 10) relays open 	
Warning stage: Earth leakage drops below warning threshold, but above alarm threshold	<ul style="list-style-type: none"> • Display shows current earth leakage • Display shows lowest detected earth leakage and time since trip • LED is solid red • Left push button is blank if current leakage is still below threshold, or reset if it is above the threshold • Relay K1 closes (8 and 9) • Relay K2 opens (8 and 10) 	
Alarm stage: Earth leakage drops below alarm threshold	<ul style="list-style-type: none"> • Display shows current earth leakage • Display shows lowest detected earth leakage and time since trip • LED flashes red • Left push button is blank if current leakage is still below threshold, or reset if it is above the threshold • Relay K2 closes (8 and 10) • Relay K1 opens (8 and 9) 	

All responses stay locked at the highest priority settings until the unit is reset either via the reset pins (TR and G), or via the left push button. The reset option will not appear unless the earth leakage is removed. It is possible to reset from the alarm stage back to the warning stage.

4.4 SELF-TEST

The Self-Test function checks the Earth Continuity, Bus Connections, and the Device Hardware.

- The Self-Test occurs automatically when Power Supply is connected, and every 24 hrs thereafter
- A manual Self-Test can run only when the device is in Standby mode
- The device displays the Hardware and Software versions during the Self-Test
- Self-Test does not clear records or settings from memory

There are three ways to begin a Self-Test

1. Connect Power Supply to the unit
2. Press Button 1 when TEST is displayed in the Label Zone
3. Use remote control switch
4. Use RS485 connected controller

A Self-Test usually takes less than 30 seconds: the screen displays progress. If the device fails any test, the Self-Test will stop and display a message.

Latching Test

Following a successful self-test, the device latches all configured relays, providing the operator time to inspect relay operated equipment. Press RESET to release latching.

Notes:

1. Latching test does not occur at initial Power Supply connection
2. Note: Insulation Monitoring does not occur or continue if the device fails the Self-Test.

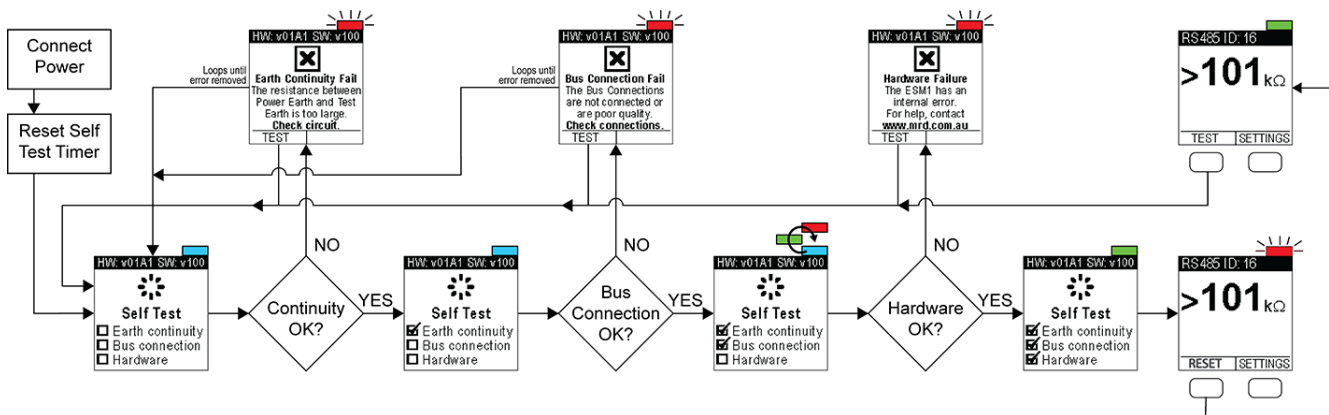

4.5 PASSWORDS (AUTHENTICATION)

If enabled, a password authenticates users and enables them to change any device setting. Without a password, user access is limited to viewing the device settings.

4.5.1 Factory Password

The Factory Password is preset; it cannot be changed. It is required to change the User Password. If you have forgotten the Factory Password, please contact your supplier or the device manufacturer.

4.5.2 Authentication (User Password ON/OFF)

Authentication may be turned ON or OFF as required. This typically occurs if the operator is repeatedly accessing the device settings during testing, or if the System Operator has reduced security requirements.

The Factory Default Setting is Authentication OFF, and no User Password exists. The operator must create a User Password before Authentication is turned ON (for the first time). To change Authentication, go to the User Pwd: screen, and follow the prompts.

Note: Enter the User Password if this has been previously set, otherwise enter the Factory Password and create a User Password. If you do not know the current User Password, reset as described in 5.4.4.

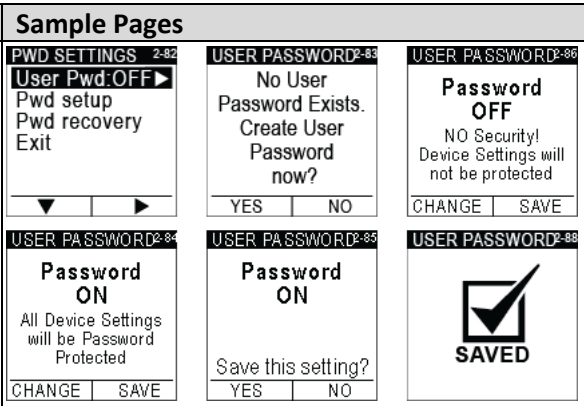
Function	Comments	Sample Pages
Enable or Disable the User Password	<p>SETTINGS >Password>User Pwd:OFF (or ON)</p> <ul style="list-style-type: none"> Instructions are on-screen Enter User Password if requested, or Create User password if requested <ul style="list-style-type: none"> Enter Factory Password Enter New User Password Confirm User Password The current Authentication status is displayed CHANGE or SAVE the status as required A splash page confirms successful completion of a change 	

4.5.3 User Password

The User Password can be changed only if the existing User Password is known; otherwise, the User Password Recovery feature must be used.

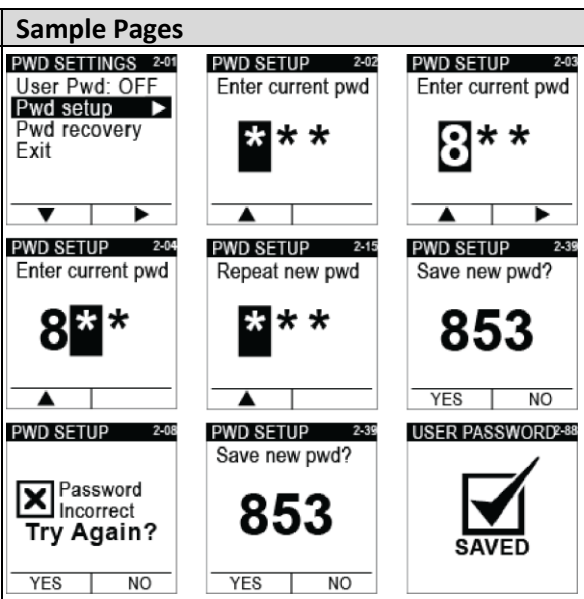
Function	Comments	Sample Pages
Change User Password	<p>SETTINGS >Password>Pwd Setup></p> <ul style="list-style-type: none"> Instructions are on-screen Enter User Password Enter New User Password Confirm New User Password If the operator enters a non-matching value, the device will offer the opportunity to Try Again SAVE the New Password when prompted A splash page confirms successful change 	

4.5.4 Recovery from Lost User Password

The device can recover from a lost User Password using the Factory Password. To replace a lost User Password: go to the Pwd Recovery page. The device will provide instructions and feedback.

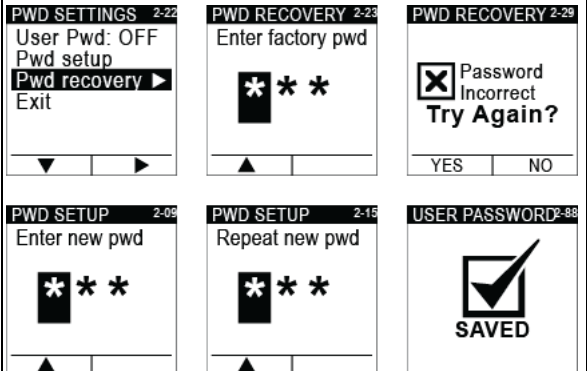

Function	Comments	Sample Pages
Recover from lost User Password	<p>SETTINGS > Password > Pwd Recovery ></p> <ul style="list-style-type: none"> Instructions are on-screen Enter Factory Password Enter New User Password Repeat New User Password Try Again option will display if the Factory Password is incorrect or if the New Password entries do not match A Saved splash page confirms successful completion of a change Record the new User Password offline. 	

4.6 WARNING SETTINGS

The Warning response has three user settable parameters, and any User can view Current Warning Settings on-screen. The setup is a similar process to Alarm setup.

Recommended Setting (IEC60364-5-53)

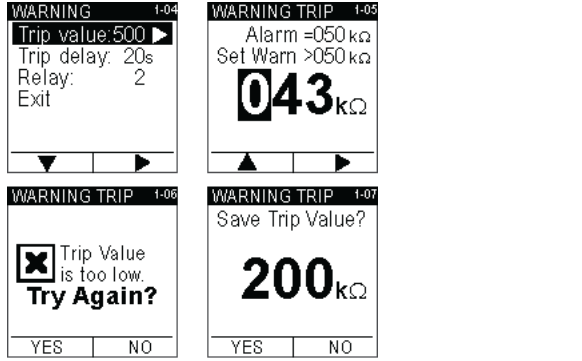

Set the Warning value to about 300Ω/V (Bus). For example, if the Bus Voltage is 600V, initially set the Warning to 300x600= 180000 =180kΩ.

Parameter	Options/Comments	Sample Pages
Activate Warning Settings	<p>SETTINGS > Warnings > Warning > CHANGE</p> <ul style="list-style-type: none"> Enter Password if requested The screen displays all current settings Parameters become selectable. 	
Warning Trip Value, R _{an1}	<p>Range: 001 – 999 kΩ</p> <ul style="list-style-type: none"> Must be <u>greater than</u> the Alarm Trip Value Set individual digits Use ▲ to cycle through individual digits. Use ► to select the next digit. For reference, the current Alarm Trip Value appears on the WARNING TRIP page. If the operator attempts to save an invalid value, the device will offer the choice to Try Again. 	
Warning Trip Delay	<p>Range: 0 - 20 seconds</p> <ul style="list-style-type: none"> The Trip Delay is the continuous length of time that the IR must remain below the Warning Trip Value, prior to Relay and LED activation. To change the setting, press ▲ to cycle through the available values. 	
Warning Activated Relay	<p>Options: Relay 1 or Relay 2</p> <ul style="list-style-type: none"> The device contains two relays: 1 & 2. The default Warning Relay is Relay 1. The Relay activates when the IR remains continuously below the Warning Trip Value for greater than the Warning Trip Delay period. Press ▲ to toggle the Relay choice. The Warning may activate the same relay as the Alarm. 	

4.7 ALARM SETTINGS

The Alarm response has three user settable parameters. Any user can view Current Alarm Settings on-screen. The setup is a similar process to Warning setup.

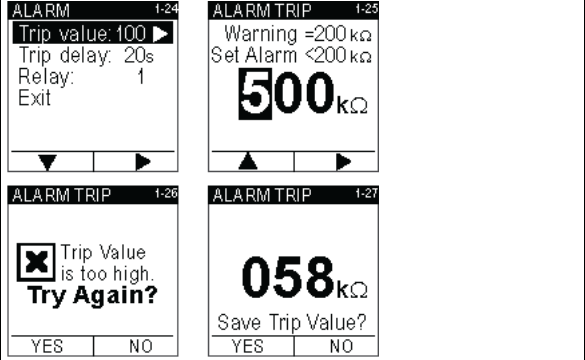





Recommended Setting (IEC60364-5-53)
Set the Alarm value to about 100Ω/V (Bus). For example, if the Bus Voltage is 600V, initially set the Warning to 100x600= 60000 =60kΩ.

Parameter	Options/Comments	Sample Pages
Activate Alarm Settings	Select SETTINGS>Warnings>Alarm>CHANGE <ul style="list-style-type: none"> Enter Password if requested The screen displays all current settings Parameters become selectable. 	
Alarm Trip Value, R _{an2}	Range: 001 – 999 kΩ <ul style="list-style-type: none"> Must be <u>less than</u> the Warning Trip Value Set individual digits Use ▲ to cycle through individual digits. Use ► to select the next digit. For reference, the current Warning Trip Value appears on the ALARM TRIP page. If the operator attempts to save an invalid value, the device will offer the choice to Try Again. 	
Alarm Trip Delay	Range: 0 - 20 seconds <ul style="list-style-type: none"> The Trip Delay is the continuous length of time that the IR must remain below the Alarm Trip Value, prior to Relay and LED activation. To change the setting, press ▲ to cycle through the available values. 	
Alarm Activated Relay	Options: Relay 1 or Relay 2 <ul style="list-style-type: none"> The device contains two relays: 1 & 2. The default Alarm Relay is Relay 2. The Relay activates when the IR remains continuously below the Alarm Trip Value for greater than the Alarm Trip Delay period. Press ▲ to toggle the Relay choice. The Alarm may activate the same relay as the Warning if required. 	

4.8 RELAY STATES





Relay 1 (K1) and Relay 2 (K2) can be set to Normally Open or Normally Closed, as required by connected equipment.

Note: The Relays fitted to this device Open when the power supply is disconnected. When power is connected, the device reads the stored Relay State setting from memory, and restores this state. This process takes ~300ms i.e. both Relays will be in the Open State for the first ~300ms following supply power connection. Equipment connected to a Normally Closed relay must be configured to compensate for this temporary Open Relay state. The device Self-Test and Reset functions do not affect the Relay States.

Parameter	Options/Comments	Sample Pages
Activate Relay States	SETTINGS>Warnings>Relay States>CHANGE <ul style="list-style-type: none"> Enter Password if requested Parameters become selectable The screen displays all current settings <ul style="list-style-type: none"> N/O = Normally Open N/C = Normally Closed 	  
Change Relay States	<ul style="list-style-type: none"> Use ▼ to highlight Relay to change, or Exit Press ► to Select Use ▲ to toggle between Relay States Press ► to Select 	  

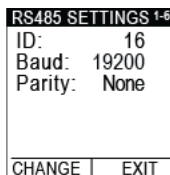
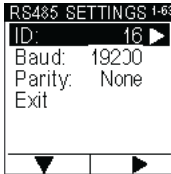
4.9 RS485 COMMUNICATION

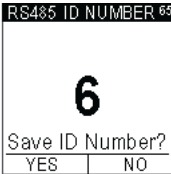
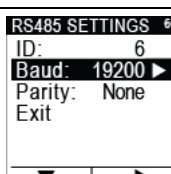
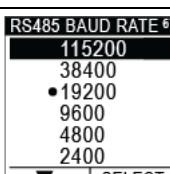
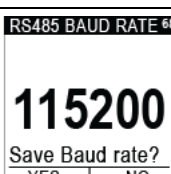
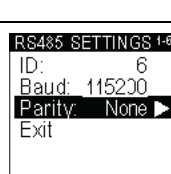
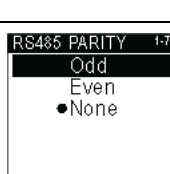
The device can communicate with and be controlled by external devices, using the RS485 ModBus. Connection parameters can be setup using an on-screen menu or via RS485 communication. The connection has three user settable parameters.

Parameter	Options/Comments	Sample Pages
	SETTINGS>RS485>CHANGE> <ul style="list-style-type: none"> Enter Password if requested Parameters become selectable The screen displays all current settings 	 
RS485 Identity	01 – 99 (Set individual digits)	  
Baud rate	2400; 4800; 9600; 19200; 38400; 115200 (Select from list)	  
Parity	Odd; Even; None (Select from list)	  

5. RS485 COMMUNICATIONS

5.1 MODBUS PROTOCOLS

Address	Register Type	Description	Value Description
10001	Coil	Remote Status Reset Activation	1: Activate
10002	Coil	Remote Reboot	1: Activate
10003	Coil	Remote Self-Test Activate	1: Activate
30001	Input	Insulation Resistance	0-999Kohm
30002	Input	Earth Connection	1: Earth Connection Error 0: No Earth Connection Error
30003	Input	Memory Data Integration	1: Memory Error 0: No Memory Error
30004	Input	Bus Connection	1: Bus Connection Error 0: No Bus Connection Error
30005	Input	HW test result	1: Hardware Error 0: No Hardware Error
30006	Input	Alarm Trip Resistance Status	0: No fault 1: Fault latched
30007	Input	Alarm Trip Threshold Setting	0 – 999Kohm
30008	Input	Warning Trip Status	0: No fault 1: Fault latched
30009	Input	Warning Trip Threshold Setting	0 – 999Kohm
30010	Input	Trip Time period	0-65535 hours
30011	Input	Last trip resistance	0-999Kohm
30012	Input	Firmware Version	100: Version 1.00
30013	Input	Self-Test Status	1: in testing
30014	Input	Self-Test Result	1: Fail
40001	Holding	Modbus ID	1-99
40002	Holding	Password	0-999
40003	Holding	Baud rate setting	0: 115200 1: 38400 2: 19200 3: 9600 4: 4800 5: 2400
40004	Holding	Parity setting	0: None 1: odd 2: even
40005	Holding	Factory Reserve	Factory Reserve
40006	Holding	Factory Reserve	Factory Reserve

5.2 CONNECTION DIAGRAM

Note: Earth Cable Shield AT ONE POINT ONLY

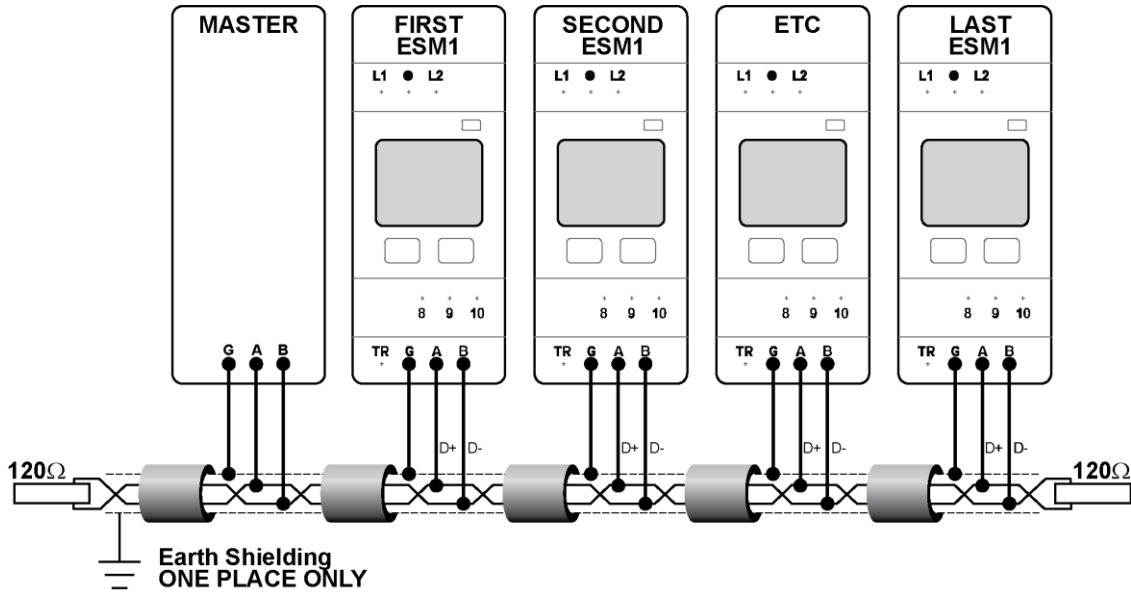

End of Manual

6. APPENDICES

A1 TECHNICAL DATASHEET

A2 WARRANTY

Congratulations on choosing an MRD EarthSense ESM1. MRD Products are designed and manufactured to the highest standards, and backed with a ONE YEAR Warranty covering materials or manufacturing defects, commencing on the date of customer receipt.

Please record your product details below.

Model	Serial Number	Date of Purchase	F.PWD	Supplier
ESM1- _____	_____	___/___/20__		

Conditions

MRD warrants your new ESM1 Insulation Monitor shall be free of material or manufacturing defects and shall operate as designed, when installed, used, and maintained according to the ESM1 Installation Guide, Technical Data Sheet, and User Manual.

This warranty does not cover:

- Normal wear and tear
- Problems not caused by materials or manufacturing defects
- Damage caused in-transit, by fluid ingress, by accident, or intentionally
- Damage resulting from installations or applications not expressly approved by MRD
- Devices that are altered in any way, including software or removal of the serial number
- Any other event, act, default or omission beyond MRD's control.

In the event of a possible warranty claim, immediately **stop using the device and contact your supplier for assistance**. It may be possible to solve the problem without returning the device.

Returns

Do not return the device unless authorised by your supplier. If a return is required, it is your responsibility to pack the device for safe shipping, and to ship the device as instructed by your supplier. Return shipping is at your expense.

MRD will inspect returned devices. We will repair or replace devices or parts of devices that are found defective due to material or manufacturing faults. We will quote to repair other problems, if requested. We will return devices determined to be No Fault Found at your expense.

Limited Liability

The benefits provided by this warranty are in addition to other rights and remedies available to the consumer under the law. In no instance shall MRD be liable for consequential damages.

For Australia Only

MRD Rail Technologies Pty Ltd goods come with guarantees that cannot be excluded under the Australian Consumer Law. You are entitled to a replacement or refund for a major failure and compensation for any other reasonably foreseeable loss or damage. You are also entitled to have the goods repaired or replaced if the goods fail to be of acceptable quality and the failure does not amount to a major failure.



This warranty is offered by:

MRD Rail Technologies Pty Ltd

235 South St, Cleveland. QLD. 4163. Australia.

+61 7 3821 5151

support@mrd.com.au

A3 WIRING DIAGRAMS

- 2-wire DC
- 3-Wire DC
- 2 Wire AC
- 4 Wire AC
- 3 Wire AC